

Tender Covering Form
Directorate of Procurement (Navy)
Through Bahria Gate

Contact: Reception 051-9262311, Bahria Gate 0331-5540649, Section: 051-9262314
Email: dpn33@paknavy.gov.pk null null

P-33/FOR Section (Contact: null, Email: null)

Tender No and Date R2201330510
Tender Description Shoes Black Leather (Safety Boot Antiskid Black)
IT Opening Date 24/02/2022
Firm Name _____
Postal Address _____
Email Address for Correspondence _____
Contact Person _____
Contact Number (Landline _____) (Mobile _____)

Document to be Attached with Quotation

Firm is to submit its proposal in a sealed envelope which shall contain 03 x Sealed Envelops as per details given below:

<u>Sealed Envelop 1 – Technical Offer in Duplicate</u>			
This envelope must contain 02 x sets of Technical Offer (01 x Original + 01 x Copy). Each Set must contain following documents as per this order and Supplier is to mark tick against each to ensure that these documents have been			
S No	Document	Original Set	Copy Set
1	Bank Challan of Rs. 200/- for DGDP registered firms and Rs. 300/- for all other firms (in favour of CMA(DP))		
2	DP-1 Form of IT with tick mark against each clause and initiated on each page		
3	DP-2 Form of IT with compliance remarks against each clause and initiated on each page		
4	Annex A of IT duly filled (with compliance remarks)		
5	Annex B & C of IT (with compliance remarks)		
6	DP-3 Form of IT (duly filled & Signed)		
7	Manufacturer Authorization letter (where applicable)		
8	Manufacturer Price list (where applicable)		
9	DRAP registration letter (in case of medical)		
10	DGDP Registration Letter (If firm is registered with DGDP)		
11	Tax Filling Proof		
<u>Sealed Envelop 2 – Earnest Money</u>			
This Envelop must contain Earnest Money only.			
<u>Sealed Envelop 3 – Commercial Offer</u>			
This Envelop must contain following documents:			
1	Firms Commercial Offer	01 x Original	
2	Principal Invoice (where applicable)	01 x Original	
3	Duly filled DP-2 Form of IT	01 x Original	

Firms Declaration

It is certified that we have submitted tender in compliance with above instructions and we understand

Firm's Authorized Signatures _____

DIRECTORATE PROCUREMENT (NAVY)

Directorate of Procurement (Navy)
Through Bahria Gate
Near SNIDS Centre,
Naval Residential Complex

Contact: Reception: 051-9262311

Bahria Gate: 0331-5540649
Section: 051-9262314

Email: dpn33@paknavy.gov.pk

M/s _____

Dated :

INVITATION TO TENDER AND GENERAL INSTRUCTIONS

Dear Sir / Madem,

1. DP (Navy) invites you to tender for the supply of stores/equipment/ services as per details given in attached Schedule to Tender (Form DP-2).

2 Caution: This tender and subsequent contract agreement awarded to the successful bidder is governed by the rules / conditions as laid down in PPRA Rules-2004 and DPP I-35 (Revised 2019) covering general terms and conditions of contracts laid down by MoDP / DGDP. As a potential bidder, it is incumbent upon you and your firm to first acquaint yourself with PPRA Rules 2004 (www.ppra.org.pk) and DPP I-35 (Revised 2019) (print copy may be obtained from DGDP Registration Cell on Phone No. 051-9270967 before participating in the tender. If your firm / company possesses requisite technical as well financial capability, you must be registered or willing to register with DGDP to qualify for award of contract, which shall be made after security clearance and provision of required registration documents mentioned in Para 15 of this DP-1.

Understood
agreed

Understood
not agreed

3 Conditions Governing Contracts. The 'Contract' made as result of this I/T (Invitation to Tender) i.a.w PPRA Rules 2004 shall mean the agreement entered into between the parties i.e. the „Purchaser and the „Seller on Directorate General Defence Purchase (DGDP) contract Form “DP-19” in accordance with the law of contract Act, 1872 and hose contained in Defence Purchase Procedure and Instructions and DPP I-35 (Revised 2019) and other special conditions that may be added to given contract for the supply of Defence Stores / Services specified herein.

Understood
agreed

Understood
not agreed

4 Delivery of Tender: The tender documents covering technical and commercial offers are to be furnished as under:-

a Commercial Offer: The commercial offer will be in single copy and indicate prices quoted in figures as well as in words in the currency mentioned in IT. It should be clearly marked in fact on a separate sealed envelope "Commercial Offer", tender number and date of opening. Taxes, duties, freight/transportation, insurance charges etc are to be indicated separately. Total price of the items quoted against the tender is to be clearly mentioned. In case of more than one option offered by the firm, DP(N) reserves the right to accept lowest technically accepted option if more than one options were accepted in Technical Scrutiny Report.

Understood agreed Understood not agreed

b Technical Offer: (Where Applicable). Should contain all relevant specifications in DUPLICATE (or as specified in IT) along with essential literature/brochure, drawings and compliance metrics in a separate sealed envelope and clearly marked "Technical Offer" without prices, with tender number and date of opening. Technical offer shall be opened first; half an hour after the date and time for receipt of tender mentioned in DP-2. Firms are to confirm/comply with IT technical specification in the following format:

Understood agreed Understood not agreed

S. No	Technical requirement as per IT	Firm's endorsement (Comply/Partially Comply/Non Comply)	Basis of C, PC of NC i.e. Refer to page or brochure	In case of non availability of enclosed proof from brochure/ Literature, quote/attach additional documents/data/undertaking as proof of compliance

(Legend: C = Fully Comply, PC = Partially Comply, NC = Not Comply)

(Firms must clearly identify where their offer does not meet or deviates from IT Specs)

c Special Instructions. Tender documents and its conditions may please be read point by point and understood properly before quoting. All tender conditions should be responded clearly. In case of any deviation due to non-acceptance of tender conditions(s), the same should be highlighted alongwith your offered conditions. Tender may however be liable to be rejected.

Understood agreed Understood not agreed

d Firms shall submit their offers in two separate envelopes (i.e. one copy of commercial offer and two copies of the technical offers as asked in the IT) and envelopes clearly marked "Technical proposal", "Commercial proposal" in bold. The commercial offer will include rates of items/services called for and the technical offer will not indicate the rates. Both types of offers are to be enclosed in separate covers and each envelope shall be properly sealed bearing of the bidder. Each cover shall indicate type of offer, number and date of IT and IT opening date. Thereafter both the envelopes (technical and commercial offer) shall be placed in one envelope (second cover) duly sealed and signed. This cover should bear the address

of the procurement agency indicating, issuance date of IT and No, with its opening date. This should be further placed in another cover (third cover), addressed and indicated in the tender documents, without any indication that there is a tender within it.

e FORM DP-1, DP-2, DP-3 and Questionnaires. Form DP-1, DP-2 (alongwith annexes), DP-3 and Questionnaires duly filled in are to be submitted with the technical offer duly stamped/signed by the authorized signatory/ person. It is pertinent to mention that all these are essential requirement for participation in the tender.

	Understood agreed	Understood not agreed
	<input type="checkbox"/>	<input type="checkbox"/>

f. The tender duly sealed will be addressed to the following:-

Directorate of Procurement (Navy)

Through Bahria Gate
Near SNIDS Centre,
Naval Residential

Contact: Reception: 051-9262311

Bahria Gate: 0331-5540649

Section: 051-9262314

Email: dpn33@paknavy.gov.pk

5 Date and Time For Receipt of Tender. Tender must reach this office by the date and time specified in the Schedule to Tender (Form DP-2) attached. This Directorate will not accept any excuse of delay occurring in post. Tenders received after the appointed/ fixed time will NOT be entertained. The appointed time will, however, fall on next working day in case of closed/forced holiday. Only legitimate/registered representatives of firm will be allowed to attend tender opening. In case your firm has sent tender documents by registered post or courier service, you may confirm their receipt at DP (Navy) on Phone No 051-9271468 well before the opening date / time.

	Understood agreed	Understood not agreed
	<input type="checkbox"/>	<input type="checkbox"/>

6 Tender Opening. Tenders will be opened as mentioned in the schedule to tender. Commercial offers will be opened at later stage if Technical Offer is found acceptable on examination by technical authorities of Service HQ. Date and time for opening of Commercial offer shall be intimated later. Only legitimate / registered representative of firm will be allowed to attend tender opening. Tenders received after date and time specified in DP-2 would be rejected without exception and returned un-opened i.a.w Rule 28 of PPRA-2004.

	Understood agreed	Understood not agreed
	<input type="checkbox"/>	<input type="checkbox"/>

7. Validity of Offer.

a. The validity period of quotations must be indicated and should invariably be 120 days from the date of opening of Technical offer or 30th June whichever is later. Firm undertakes to extend validity of offer if required by equal number of original bid period (i.e. 120 days as per original offer) i.a.w PPRA Rule-26.

	Understood agreed	Understood not agreed
	<input type="checkbox"/>	<input type="checkbox"/>

b. The quoting firm will certify that in case of an additional requirement of the contract items (s) in any qty(s) within a period of 12 months from the date of signing the contract, these will also be supplied at the ongoing contract rates with discount.

- | | | | |
|-----|---|--------------------------|--------------------------|
| 8 | <u>Part Bid</u> Firm may quote for the whole or any portion, or to state in the tender that the rate quoted, shall apply only if the entire quantity/range of stores is taken from the firm. The Director Procurement reserves the right of accepting the whole or any part of the tender or portion of the quantity offered, and firm shall supply these at the rate quoted. | Understood
agreed | Understood
not agreed |
| | | <input type="checkbox"/> | <input type="checkbox"/> |
| 9 | <u>Quoting of Rates.</u> Only one rate will be quoted for entire quantity, item-wise. In case quoted rates are deliberately kept hidden or lumped together to trick other competitors for winning contract as lowest bidder, DP(N) reserves the right to reject such offers on-spot besides confiscating firms Earnest Money / Bid Security and take appropriate disciplinary action. Conversion rate of FE/LC components will be considered w.e.f. opening of commercial offer as per PPRA Rule-30(2). | Understood
agreed | Understood
not agreed |
| | | <input type="checkbox"/> | <input type="checkbox"/> |
| 10. | <u>Return of I/T.</u> ITs are to be handled as per following guidelines: | Understood
agreed | Understood
not agreed |
| | a. In case you are Not quoting, please return the tender inquiry stating the reason of NOT quoting. In case of failure to return the ITs either quoted or not quoted consequently on three occasions, this Directorate, in the interest of economy, will consider the exclusion of your firms name from our future distribution list of invitation to tender. | <input type="checkbox"/> | <input type="checkbox"/> |
| | b. For registered firm(s), case will be referred to DGDP for necessary administrative action if firms registered / indexed for tendered items/stores do not quote / participate. | | |
| | c. It is a standard practice to invite all firm(s) including those unregistered with DGDP who gave their preliminary budgetary/ technical proposals to end users / indentors. If your firm has been invited to participate in the tender, you must either participate in tender. In case of your inability to do so, you must inform DP (Navy) by a formal letter/email. | | |
| 11. | <u>Withdrawal of Offer.</u> Firms shall not withdraw their commercial offers before signing of the contract and within validity period of their offers. In case the firm withdraws its offer within validity period and before signing of the contract, Earnest Money of the firm shall be confiscated and disciplinary action may also be initiated for embargo up to 01 year. | Understood
agreed | Understood
not agreed |
| | | <input type="checkbox"/> | <input type="checkbox"/> |
| 12. | <u>Provision of Documents in case of Contract.</u> In case any firm wins a contract, it will deposit following documents before award of contract: | Understood
agreed | Understood
not agreed |
| | a. Proof of firms financial capability. | | |
| | b. Foreign Seller has to provide its Registration Number issued by respective Department of Commerce authorizing export of subject stores. | <input type="checkbox"/> | <input type="checkbox"/> |
| | c. Principal/Agency Agreement. | | |
| | d. Registration with DGDP (Provisional Registration is mandatory) | | |
| 13. | <u>Treasury Challan.</u> | Understood
agreed | Understood
not agreed |
| | a. Offers by registered firms must be accompanied with a Challan form of Rs.200/- (obtainable from State Bank of Pakistan/Government Treasury) and debit able to Major Head C02501-20, Main Head-12, Sub Head 'A' Miscellaneous (Code Head 1/845/30). Each offer will be covered by one Challan. | <input type="checkbox"/> | <input type="checkbox"/> |
| | b. Firms, un-registered / un-indexed with GDP (Registration Section) are to participate in the tender by submitting Challan Form of Rs 300 in favour of CMA (DP). | | |

14. Earnest Money/Tender Bond: Please ensure Earnest Money is contained in a separate envelop (not inside Technical or commercial offer). Offer is liable to be rejected in case Earnest Money is packed inside commercial or Technical offer. Your tender must be accompanied by a Call Deposit Receipt (CDR) in favor of CMA (DP), Rawalpindi for the following amounts:-

Understood agreed Understood not agreed

a. Submitting improper Earnest Money/Bid Security furnished with tender is strictly in conformity of tender/IT conditions (Clause 14 of DP-1 and clause 10 of DP-2) on the subject. We have no objection on confiscation of Earnest Money/Bid security and rejection of our offer in case amount of Earnest Money/Bid Security is improper/insufficient in violation of IT condition.

b. Rates for Contract. The rate of earnest money and its maximum ceil for different categories OF FIRMS would be as under:-

ⓐ Registered/Indexed/Pre-Qualified Firms. 2% of the quoted value subject to maximum ceiling of Rs. 0.500 Million.

ⓑ Registered/Pre-Qualified but Un-indexed 3% of the quoted value subject to maximum ceiling of Rs. 0.750 Million.

ⓒ Unregistered/not Pre-Qualified/Un-indexed 5% of the quoted value subject to maximum ceiling of Rs. 1.000 Million.

c. Return of Earnest Money. (i) Earnest money to the unsuccessful bidders will be returned on finalization of the contract.
(ii) Earnest money of the firm/firms with whom contract is concluded will be returned on submission of Bank Guarantee and its acceptance by CMA (DP).

15. Documents for provisional registration: In case your firm wins a contract on Earnest Money (EM) , it will deposit following documents to DGDP (Registration Section) before the award of contract for provisional registration:-

Understood agreed Understood not agreed

S No	Local Supplier	Foreign Supplier
a.	Three filled copies of SVA-8121 of each member of management.	Three filled copies of SVA-8121-D of each member of management.
b.	Three filled copies of SVA-8121-A	Three filled copies of SVA-8121.
c.	Three photocopies of NIC for each member of management.	Three photocopy of Resident Card or equivalent identification Card for each member of management.
d.	Three PP size photographs for each member of management.r	Three PP size Photographs for each member of management.
e.	Challan Form	Challan Form
f.	Bank Statement for last one year.	Financial standing/audit balance
g.	Photocopy of NTN	Photocopy of passport
h.	Foreign Principal Agency Agreement in case of local agent.	Agency Agreement in case of Trading House/ Company/ Exporter /Stockiest etc.

16. . Inspection Authority. CINS, Joint Inspection will be carried out by INS, Consignee and Specialist User or a team nominated by Pakistan Navy. CINS inspection shall be as prescribed in DPP & I-35 (Revised 2019) or as per terms of the contract.

Understood agreed Understood not agreed

17. . Condition of Stores. Brand new stores will be accepted on Firms Warranty/Guarantee Form DPL-15 enclosed with contract.

Understood agreed Understood not agreed

18. Documents Required. Following documents are required to be submitted along with the quote:

Understood agreed Understood not agreed

a. OEM/Authorized Dealer/Agent Certificate along with OEM Dealership Evidence.

b. The firm/supplier shall provide correct and valid e-mail and Fax No to CINS and DP(N). Supplier/contracting firm shall either provide OEM Conformance Certificate to CINS or is to be e-mailed to CINS under intimation to DP (Navy). Hard copy of COC must follow in any case through courier. On receipt, CINS shall approach the OEM for verification of Conformance Certificates issued by OEM. Companies/firms rendering false OEM Conforming Certificates will be blacklisted.

c. Original quotation/Principal/OEM proforma invoice.

d. In case of bulk proforma invoice, a certificate that prices indicated in the bulk proforma invoice have not been decreased since the date of bulk proforma invoice from the manufacturers/suppliers.

e. Submit breakup of cost of stores/services on the following lines:

(i) Imported material with break down item wise along-with import duties.

(ii) Variable business overheads like taxes and duties imposed by the federal/provincial government as applicable:-

(1) General Sales Tax

(2) Income Tax

(3) Custom Duty. PCT code along with photocopy of the related page is to be attached where applicable.

(4) Any other tax

(iii) Fixed overhead charges like labour, electricity etc.

(iv) Agent commission/profit, if any.

(v) Any other expenditure/cost/service/remuneration as asked for in the tender.

19. . Rejection of Stores/Services. The stores/services offered as a result of contract concluded against this tender may be rejected as follows:

Understood agreed Understood not agreed

a. 1st rejection on Govt. expense

b. 2 nd rejection on supplier expense

c. 3rd rejection contract cancellation will be initiated.

20. . Rejection of Stores/Services. To ensure timely and correct supply of stores the firm will furnish an unconditional Bank Guarantee (BG in the currency in which contract is concluded) from a schedule Bank of Pakistan for an amount upto 10 % of the contract value (excluding Taxes, duties/freight handling charges) on a Judicial Stamp Paper (All pages) of the value of (Rs 100.00) as per prescribed format or in shape of CSD/Bank draft. The Bank Guarantee shall be endorsed in favour of CMA (DP) Rawalpindi who is the Accounts Officer specified in the contract. The CMA (DP) Rawalpindi has the like power of seeking encashment of the Bank Guarantee as if the same has been demanded by the purchaser himself. The Bank Guarantee shall be produced by the supplier within 30 days from the date of issue of the contract and remain valid for upto 60 days after completion of warranty period and remain in force till one year ahead of the delivery date given in the contract. If delivery period is extended, the supplier shall arrange the extension of Bank Guarantee within 30 days after the original delivery period to keep its validity always one year ahead of the extended delivery period. The BG form can be obtained from DP(N) on e-mail address given on page 1. Format of BG is enclosed at Annex B.

Understood
agreed

Understood
not agreed

21. . Integrity Pact. There shall be “zero tolerance” against bribes, gifts, commission and inducement of any kind or their promises thereof by Supplier / Firm to any Government official / staff whether to solicit any undue benefit, favour or otherwise. Following provisions must be clearly read and understood for strict compliance:

Understood
agreed

Understood
not agreed

a. Integrity Pact shall be applicable to all tenders / contracts irrespective of their financial value. However, a written Integrity Pact shall be signed for contracts exceeding Rs 10 Million between the procuring agency and the supplier / contractor i.a.w Rule-7 of PPRA-2004. The form is available at www.ppra.org.pk or can be requested at dpn@paknavy.gov.pk

b. If a Supplier / Contractor is found involved in any unbusiness-like / unethical activity, same would be considered a serious breach of the Integrity Pact. DP (Navy) shall take severe disciplinary action against that person(s) and the firm / company, which may include, but not limited to, PERMANENT BLACKLISTING of firm / company through DGDP and legal action against the individual (s) involved as per Pakistans Code of Criminal Procedure.

c. It is strictly forbidden to socialize, call or meet any official / staff of DP (Navy) in private or during off hours. If any official / staff from Purchaser side asks for any undue favour or gratification directly or indirectly, the matter is to be immediately brought to the personal notice of Director Procurement (Navy) on Respective Section Tel: 051-9271468 or through a personal meeting in office. Privacy of firms and their Reps sharing such information will be guaranteed without any prejudice to their normal business activities.

22. . Correspondence. All correspondence will be addressed to the Purchaser i.e. DP (Navy). Correspondence with regard to payment or issue of delivery receipt may be addressed to CMA Rawalpindi and Consignee respectively with copy endorsed to the DP (Navy).

Understood
agreed

Understood
not agreed

23. . Pre-Shipment Inspection. PN may send a team of officers including DP(N) member for the inspection of major equipments and machinery items at OEM premises as per terms of contract. If not already provided for and mentioned in the I.T, firm(s) must clarify the place, number of persons, duration and whether expenses on such visits would be borne by the Purchaser or Contractor. In case contractor is responsible for bearing such expenses, detailed breakdown of the same should be given separately in the commercial offer.

Understood
agreed

Understood
not agreed

24. Amendment to Contract. Contract may be amended/modified to include fresh clause (s) modify the existing clauses with the mutual agreement by the supplier and the purchaser; such modification shall form an integral part of the contract

Understood
agreed

Understood
not agreed

25. Discrepancy. The consignee will render a discrepancy report to all concerned within 60 days after receipt of stores for discrepancies found in the consignment. The quantities found short are to be made good by the supplier, free of cost.

Understood
agreed

Understood
not agreed

26. Price Variation.

Understood
agreed

Understood
not agreed

- a. Prices offered against this tender are to be firm and final.
- b. Where the prices of the contracted stores/raw material are controlled by the government or an agency competent to do so on government behalf then price increase/decrease will be allowed at actual on case to case basis on production of government notification by the Supplier for the subject stores where the firms are contractually obliged and bound to produce the stores from raw materials supplied by government/State controlled departments in consultation with Military Finance.
- c. Except for calculation or typographical errors, the rates of the contracts not having a price variation clause PVC clause will not be increased subsequently. But when such an increase is considered desirable in the interest of expeditious supply of stores and is necessitated by the circumstances beyond the control of the Supplier, the case may be decided accordingly.

27. Force Majeure.

Understood
agreed

Understood
not agreed

- a. The supplier will not be held responsible for any delay occurring in supply of equipment due to event of Force Majeure such as acts of God, War, Civil commotion, Strike, Lockouts, Act of Foreign Government and its agencies and disturbance directly affecting the supplier over which events or circumstances the supplier has no control. In such an event the supplier shall inform the purchaser within 15 days of the happening and within the same timeframe about the discontinuation of such circumstances / happening in writing. Non-availability of raw material for the manufacture of stores, or of export permit for the contracted stores from the country of its origin, shall not constitute Force Majeure.
- b. The Supplier shall provide the Purchaser with all the necessary proof of the occurrence of the events and its effect on the contract performance within 30 days from the start to force majeure event.
- c. The Purchaser shall be entitled to conduct investigation into the cause of delay reported by the Supplier.
- d. Where the delay was due to genuine force majeure event it shall extend the delivery for a period of equal to the period in which such force majeure remains operative.
- e. Such extension in delivery period, due to force majeure, shall not entitle the Suppliers to claim any extra from the Purchaser.

28. Arbitration. Parties shall make their attempt to settle all disputes arising under this contract through friendly discussions in good faith. In the event that either party shall perceive such friendly discussion to be making insufficient progress towards settlement of dispute (s) at any time, then such party may be written notice to the other party refer the dispute (s) to final and binding arbitration as provided below:

Understood agreed Understood not agreed

- a. The dispute will be referred for adjudication to two arbitrators one to be nominated by each party, who before entering upon the reference shall appoint an umpire by mutual agreement, and if they do not agree a judge of the Superior court shall be requested to appoint the umpire. The arbitration proceedings shall be held in Pakistan and under Pakistani Law.
- b. The venue of the arbitration shall be the place from which the contract is issued or such other places as the Purchaser at his discretion may determine.
- c. The arbitration award shall be firm and final.
- d. In course of arbitration the contract shall be continuously be executed except that part which is under arbitration
- e. All proceedings under this clause shall be conducted in English language and in writing

29. Court of Jurisdiction. In case of any dispute only court of jurisdiction at Rawalpindi, Pakistan shall have jurisdiction to decide the matter

Understood agreed Understood not agreed

30. Liquidated Damages(LD). Liquidated Damages upto 2% per month are liable to be imposed on the suppliers by the purchaser in accordance with DPP & I-35, if the stores supplied after the expiry of the delivery date without any valid reasons. Total value of LD shall not exceed 10% of the contract value.

Understood agreed Understood not agreed

31. Risk Purchase. In the event of failure on the part of supplier to comply with the contractual obligations the contract will be cancelled at the Risk and Expense (RE) of the supplier in accordance with DPP & I-35.

Understood agreed Understood not agreed

32. Compensation Breach of Contract. If the contractor fails to supply the contracted stores or contract is cancelled either on RE or without RE or contract become ineffective due to default of supplier / seller or stores / equipment declared defective and caused loss to the Government, contractor shall be liable to pay to the Government compensation for loss or inconvenience resulting for his default or from the rescission of his contract when such default or rescission take place such compensation will be in excess to the RE amount, if imposed by the competent authority. Compensation amount in terms of money will be decided by the purchase officer and will be deposited by contractor / seller in Government treasury in the currency of contract.

Understood agreed Understood not agreed

33. Gratuities/Commission/Gifts. No commission, rebate, bonus, fee or compensation in any form shall be paid to any local or foreign agent, consultant representative, sales promoter or any intermediary by the Manufacturer/Supplier except the agent commission payable as per the agent commission policy of the government and as amended from time to time and given in the contract. Any breach of such clause(s) of the contract by Manufacturer/Supplier and/or their sole nominated representative may result in cancellation of the contract blacklisting of the Manufacturer/Supplier financial penalties and all or any other punitive measure which the purchaser may consider appropriate.

Understood
agreed Understood
not agreed

34. Termination of Contract.

Understood
agreed Understood
not agreed

a. If at any time during the currency of the contract the Purchaser decides to terminate the contract for any reason whatsoever (other than for reasons of Non-Delivery) he shall have right to do so by giving the Supplier a registered notice to that effect. In that event the Purchaser will accept delivery at the contract price and terms of such stores/goods/services which are in the actual process of manufacture that is completed and ready for delivery within thirty days after receipt by the Supplier of such notice.

b. In the case of remainder of the undelivered stores/goods/services the Purchaser may elect either:

ⓐ To have any part thereof completed and take the delivery thereof at the contract price or.

ⓑ To cancel the remaining quantity and pay to the Supplier for the articles or sub-components or raw materials purchased by the Supplier and are in the actual process of manufacture at the price to be determined by the Purchaser. In such a case materials in the process of manufacture shall be delivered by the Supplier to the Purchaser.

c. Should the Supplier fail to deliver goods/services in time as per quality terms of contract or fail to render Bank Guarantee within the stipulated time period or any breach of the contract the Purchaser reserves the right to terminate/cancel the contract fully or any part thereof at the risk and

35. Rights Reserved. Directorate of Procurement (Navy), Rawalpindi reserves full rights to accept or reject any or all offers including the lowest. Grounds for such rejections may be communicated to the bidder upon written request, but justification for grounds is not required as per PPRA Rule 33 (1).

Understood
agreed Understood
not agreed

36. Application of Official Secrets Act, 1923. All the matters connected with this enquiry and subsequent actions arising there from come within the scope of the Official Secrets Act, 1923. You are, therefore, requested to ensure complete secrecy regarding documents and stores concerned with the enquiry and to limit the number of your employees having access to this information.

Understood
agreed Understood
not agreed

37. Acknowledgment. Firms will send acknowledgement slips within 07 days from the date of downloading of IT from the PPRA Website i.e. WWW.PPRA.ORG.PK

Understood agreed Understood not agreed

38. Disqualification. Offers are liable to be rejected if:-

Understood agreed Understood not agreed

- a. Received later than appointed/fixed date and time.
- b. Offers are found conditional or incomplete in any respect.
- c. There is any deviation from the General /Special/Technical Instructions contained in this tender.
- d. Forms DP-1, DP-2 (along with Annexes), and DP-3 duly signed, are NOT received with the technical offer.
- e. Taxes and duties, freight/transportation and insurance charges NOT indicated separately as per required price breakdown mentioned at Para 17.
- f. Treasury challan is NOT attached with the technical offer.
- g. Multiple rates are quoted against one item.
- h. Manufacturers relevant brochures and technical details on major equipment assemblies are not attached in support of specifications.
- i. Subject to restriction of export license.
- j. Offers (commercial/technical) containing non-initialed/ unauthenticated amendments/corrections/overwriting.
- k. If the validity of the agency agreement is expired.
- l. The commercial offer against FOB/CIF/CandF tender is quoted in local currency and vice versa.
- m. Principals invoice in duplicate clearly indicating whether prices quoted are inclusive or exclusive of the agent commission is not enclosed.
- n. Earnest money is not provided.
- o. Earnest Money is not provided with the technical offer (or as specified).
- p. If validity of offer is not quoted as required in IT or made subject to confirmation later.
- q. Offer made through Fax/E-mail/Cable/Telex.
- r. If offer is found to be based on cartel action in connivance with other sources/ participants of the tender.
- s. If OEM and principal name and complete address is not mentioned.
- t. Original Principal Invoice is not attached with offer.

39. Appeals by Supplier/Firm. Any aggrieved Supplier/Firm against the decision of DP (N) or CINS or any other problematic area towards the execution of the contract may prefer an Appeal to Standing Appeal Committee (SAC) comprising PN Officers and military finance rep at Naval headquarters, Islamabad. The detail and timeline for preferring appeals is given below:

Understood agreed Understood not agreed

S.No	Cetegary of Appeal	Limitation Period
a	Appeals for liquidated damages	Within 30 days decision
b	Appeals for reinstatement of contracts	Within 30 days decision
c	Appeals for risk and expense amount	Within 30 days decision
d	Appeals for rejection of stores	Within 30 days decision
e	Appeals in all other Cases	Within 30 days decision

40. Limitation Any appeal received after the lapse of timelines given in para 39 above shall not be entertained.

Understood
agreed

Understood
not agreed

41. For Firms not Registered with DGDP. Firms not registered with DGDP undertake to apply for registration with DGDP prior signing of Contract. Details can be found on DGDP website ww.dgdp.gov.pk. These firms can participate in tender law paras 12 and 14 above

Understood
agreed

Understood
not agreed

42. Firms which are not registered with DGDP should initiate provisional registration in accordance with Para 41. Besides, ground check by Field Security (FS) Team will be made for security clearance related to participation in the tender after technical opening. Firms undertake to provide following documents for ground check by FS Team:

Understood
agreed

Understood
not agreed

- a. NTN
- b. Income Tax Return
- c. Sales Tax Return
- d. Sales Tax Certificate
- e. Chamber of Commerce Industry Certificate
- f. Professional Tax Certificate (Excise and Taxation)
- g. Office/Home/Ware House Property documents
- h. Utility Bills (Phone/Electricity)
- j. Firm Vehicle/Personal Vehicle
- k. CEO Visiting Card/NIC Copy, 03Xspecimen signature of CEO
- l. DGDP Registration letter
- m. Firm Bank Statement
- n. Non Black List Certificate
- p. 2 X Witness + CNIC and Mobile Numbers
- q. Police Verification
- r. Agency Agreement
- s. OEM Certificate
- t. ISO Certificate
- u. Stock List with value
- v. Company Profile/Broachers
- w. Employees List
- x. Firm Categories
- y. Sole Proprietor Certificate
- z. Partnership Deed
- aa. Pvt Limited
- ab. Memorandum of Articles
- ac. Form 29 and Form A
- ad. Incorporation Certificate

43. We solemnly undertake that all IT clauses marked as "Understood and Agreed" shall not be changed / withdrawn after tender opening. The IT provisions accepted shall form the baseline for subsequent contract negotiations.

Understood
agreed

Understood
not agreed

44. The above terms and conditions are confirmed in total for acceptance.

Understood
agreed

Understood
not agreed

45. Format of DPL-15 (warranty form) and PBG are enclosed as Annex A and B.

Understood
agreed

Understood
not agreed

Sincerely yours,

(To be Signed by Officer Concerned)

Rank: _____

NAME: _____

DPL-15 (WARRANTY)

FIRM'S NAME M/s _____

1. We hereby guarantee that the articles supplied under the terms of this contract are produced new in accordance with approved drawings/specification and in all respect in accordance with the terms of the contract, and the materials used whether or not of our manufacture are in accordance with the latest appropriate standard specifications, as also in accordance with the terms of complete of good workmanship throughout and that we shall replace FOR/DDP Karachi free of cost every article or part thereof use or in use shall be found defective or not within the limits and tolerance of specifications requirement or in any way not in accordance with the terms of the contract.

2. In case of our failure to replace the defective stores free of cost within a reasonable period, we shall refund the relevant cost FOR/DPP Karachi (As the case may be in currency in with received).

3. This warranty shall remain valid for 01 Year after the acceptance of stores by the end user

The signature must be the same as that on the tender/contract, or if otherwise must be shown to be the signature of a person capable of giving a guarantee on behalf of the contractor

SIGNATURE _____

DATE _____

PLACE _____

BANK GUARANTEE FOR PERFORMANCE ON
JUDICIAL STAMP PAPER OF RS. 100/- OR
AS SUITABLE TO THE AMOUNT OF BG

(i) Contract No. _____ dated _____
(ii) Name of Firm/Contractor _____
(iii) Address of Firm/Contractor _____
(iv) Name of Guarantor _____
(v) Address of Guarantor _____
(vi) Amount of Guarantee Rs. _____
(_____) (in words)
(vii) Date of expire of Guarantee _____

To: The President of Islamic Republic of Pakistan through the
Controller of Military Accounts (Defence Purchase) Rawalpindi.

Sir

1. Whereas your good self have entered into Contract No. _____ dated _____
with Messers _____

(Full Name and Address)

hereinafter referred to as our customer and that one of the conditions of the Contract is
the submission of unconditional Bank Guarantee by our customer to your good self for a
sum of Rs. _____ Rupees/FE (as applicable) _____

2. In compliance with this stipulation of the contract, we hereby agree and undertake as
under: -

a. To pay to you unconditionally on demand and/or without any reference to our Customer
and amount not exceeding the sum or Rs. _____ Rupees or
FE (as applicable) _____ as would be mentioned in
your written Demand Notice.

b. To keep this Guarantee in force till _____.

c. That the validity of this Bank Guarantee shall be kept one clear year ahead of the
original/extended delivery period or the warrantee of the stores which so ever is later in
duration on receipt of information from our Customer i.e. M/s _____
or from your office. Claim, if any must be duly received by us on or before this day. Our
liability under this Bank Guarantee shall cease on the closing of banking hours on the last
date of the validity of this Bank Guarantee. Claim received thereafter shall not be
entertained by whether you suffer a loss or not. On receipt of payment under this
guarantee, this document i.e. Bank Guarantee must be clearly cancelled, discharged and
returned to us.

d. That we shall inform your office regarding termination of the validity of this Bank Guarantee one clear month before the actual expiry date of this Guarantee.

e. That with the consent of our customer you may amend/alter any term/clause of the contract or add/delete any term/clause to/from this contract without making any reference to us. We do not reserve any right to receive any such amendment/alternation or addition/deletion provided such like actions do not increase our monetary liability under this Bank Guarantee which shall be limited only to Rs. _____(Rupees _____).

f. That the Bank Guarantee herein before given shall not be affected by any change in the constitution of the Bank or Customer/Seller or Vendor.

g. That this an unconditional Bank Guarantee, which shall be encashed on sight on presentation without any reference to our Customer/Seller or Vendor.

Guarantor

Dated: _____

(Bank Seal and
Signatures)

AFFIDAVIT/UNDERTAKING
(WORTH RS, 100/- ON JUDICAL STAMP PAPER)

Mr _____ Authorized signatory/
Partner/MD of M/s _____, do hereby solemnly affirm to DGP
(Army), DP (Navy), DP (Air) and Directorate General Defence Purchase, Ministry of Defence
Production, Rawalpindi that our firm M/s _____ has applied for registration
with Director General Defence Purchase (DGDP) duly completed all the documents required by
registration section on _____ (date) i,e before signing the contract. I certify that the above
mentioned statement is correct. In case it is detected on any stage that our firm has not applied
for registration with Director General Defence Purchase or statement given above is incorrect,
our firm will be liable for disciplinary action initiated (i,e debarring, the firm do business with
other Defence Establishment and Govt Agencies). I also accept that any disciplinary action
taken will not be challenged in any Court of Law.

Station: _____
Date: _____

Signature: _____
Name: _____
Appointment in Firm: _____

ATTESTED BY OATH COMMISSIONER WITH STAMP

INVITATION TO TENDER FORM

1 Schedule to Tender No. 125028\R2201330510 Dated null This tender will be closed for acceptance at 1030 Hours and Will be opened at 11:00 Hours on 2022-02-24 Please drop tender in the Tender Box No. 203

2 You are requested to please use this Performa for price quotation, fill in the prices, affix your stamp on the same, sign it and forward it in original as your Commercial offer along with the covering letter of your firm. If you do not use this form as price quotations your offer might be rejected.

3. You are requested to please attach DP-1 and DP-3 alongwith your quotation duly signed and stamped. Same are available at www.ppra.org.pk

S NO	DETAIL OF STORES	QTY	UNIT PRICE	TOTAL PRICE
1	8430500100698 Shoes Black Leather (Safety Boot Antiskid Black) Size 8	3000.0 PAIRS		
	Detailed: Technical Specification Special Instructions: As Per Annex A			
2	8430500100700 Shoes Black Leather (Safety Boot Antiskid Black) Size 10	5000.0 PAIRS		
	Detailed: Technical Specification Special Instructions: As Per Annex A			
3	8430500100533 Shoes Black Leather (Safety Boot Antiskid Black) Size 11	3000.0 PAIRS		
	Detailed: Technical Specification Special Instructions: As Per Annex A			
4	8430500100699 Shoes Black Leather (Safety Boot Antiskid Black) Size 9	2000.0 PAIRS		
	Detailed: Technical Specification Special Instructions: As Per Annex A			
Above mentioned price includes 17% sale Tax (Please tick Yes or No)		Yes		No
Grand Total				

Terms and Conditions

1. Terms of Payment As per Annex B
2. Origin of OEM indigenous
3. Origin of Stores indigenous
4. Technical Scrutiny Report Required
5. Delivery Period 100% by 31 October 2022
6. Currency PAK RUPEES
7. Basis for acceptance FOR
8. Bid validity The validity period of quotations must be indicated and should invariably be 120 days from the date of opening of technical offer or 30th June whichever is later. Firm undertakes to extend validity of offer if required by equal number of original bid period (i.e. 120 days as per original offer) i.a.w PPRA Rule-26.
9. Tendering procedure Single Stage - Two Envelopes
bidding procedure will be followed . PPRA Rule 36 refers.

10. Earnest Money/Tender Bond

Please ensure Earnest Money is contained in a separate envelop (not inside Technical or commercial offer). Offer is liable to be rejected in case Earnest Money is packed inside commercial or Technical offer. Your tender must be accompanied by a Call Deposit Receipt (CDR) in favor of CMA (DP), Rawalpindi for the following amounts:-

a. Submitting improper Earnest Money/Bid Security Earnest Money/Bid Security furnished with tender is strictly in conformity of tender/IT conditions (Clause 14 of DP-1 and clause 10 of DP-2) on the subject. We have no objection on confiscation of Earnest Money/Bid security and rejection of our offer in case amount of Earnest Money/Bid Security is improper/insufficient in violation of IT condition.

b. Rates for Contract. The rate of earnest money and its maximum ceil for different categories OF FIRMS would be as under:-

(i) Registered/Indexed/Pre-Qualified Firms. 2% of the quoted value subject to maximum ceiling of Rs. 0.500 Million.

(ii) Registered/Pre-Qualified but Un-indexed 3% of the quoted value subject to maximum ceiling of Rs. 0.750 Million.

(iii) Unregistered/not Pre-Qualified/Un-indexed 5% of the quoted value subject to maximum ceiling of Rs. 1.000 Million.

c. Return of Earnest Money. (i) Earnest money to the unsuccessful bidders will be returned on finalization of the contract.
(ii) Earnest money of the firm/firms with whom contract is concluded will be returned on submission of Bank Guarantee and its acceptance by CMA (DP).

13. Special Note.

All Participating firms must submit technical offers in duplicate (one for TSR committee and one for DP (Navy) record).

- a. Unregistered (Not registered with Directorate General Defense Purchase) firms must provide the documentary evidence of their financial capability to undertake the project.
- b. Unregistered firms are to submit a certificate along with their Technical offer stating that the firm is not black listed by any government organization and not under disciplinary trial or embargo.
- c. Only registered suppliers on Active Taxpayers List (ATL) of FBR are eligible to participate in the Tender and submit quote.
- d. Release of payments is subject to mandatory submission of Filer Certificate duly issued by FBR showing the name of supplier on Active Taxpayers List (ATL). No payment will be released by CMA (DP) unless latest Filer Certificate duly issued by FBR showing the name of supplier on its Active Taxpayers list is submitted alongwith payment documents.
- e. In case of Pakistani firms, sales tax, NTN and income tax registration certificates are to be attached with the offer. These certificates are mandatory with the BID, otherwise offer shall be REJECTED.
- f. Company registration certificates are to be attached with offer.
- g. Requisite amount of earnest money (in shape of CDR/Demand Draft/Pay Order in the favour of CMA (DP) is to be attached in separate envelop in sealed condition with the Technical offer. Photocopy of the same shall also be attached with DP-2 as a testimony. Cheques/crossed cheques shall not be accepted. Technical offers received without earnest money shall not be accepted and will be rejected on spot.
- h. Duly completed Form DP-1 and DP-3 are to be attached with Technical Offer.
- i. DP-2 Form shall also be submitted with Technical Offer without mentioning of prices. Moreover, compliance or otherwise against each para/requirement of Annex A, B & C duly signed and stamped by firm authorized rep is to provide for technical scrutiny.
- j. Price preference is admissible to local manufacturers over foreign vendors as per PPRA Rule 24 and Govt of Pakistan (Ministry of Commerce) SRO 827 (I)/2001.

Note: In case of failure to comply above instructions, Terms and conditions, offer will liable for rejection.



MDITD
NSSD WEST WHARF
ROAD KARACHI

PN/MDITD/03/632627

58410

See Distribution

08 May 2017

AMENDMENT IN PN SPECIFICATION ANTI SKID SHOES

Reference:

- A. PN/COMDEP/CSD N/03/629049 dated: 04-05-2017
- B. PN/MDITD/03/629197 dated: 04-05-2017
- C. PN/NS Dte/03/624897 dated: 02-05-2017
- D. PN/MDITD/03/600509 dated: 10-04-2017

Aprpos letter at reference A, following amendment in PN Specification 05/2017 promulgated vide reference B, has been done after inclusion of sizes from 03 to 14:

Amend para 8.4

FOR from 03 to 11

READ from 03 to 14

Amend Annex A

Amended page is enclosed for inclusion at your end please.

IJAZ AHMAD
Capt PN
DITD

Encl(s):

- 1. **Annex A**

Distribution:

Viewed by: Lt PN Rana Mehdi Hassan GO I P/NSD. Dated: 17 Nov 2021 15:16:03

External:

Action:

DNS

DP NAVY

CINS

CO PNCSD

Information:

HQ COMLOG

Attn: SSO (S)

COMDEP

Attn: SSO

PN/MDITD/03/632627 approved by DITD Capt PN Ijaz Ahmad on 08 May 2017

Note: Computer generated documents do not require signature

Viewed by: Lt PN Rana Mehdi Hassan GO I PNCSD. Dated: 11 Nov 2021 15:16:03

MEASUREMENTS AND DIMENSIONS
SIZE ROLL OF LAST MEASUREMENTS IN MILLIMETERS

NSN / Pattern No.	Size of Footwear	Girth	Length on size Stick / Bottom
0017500000962	3	225	239
0017500000958	4	230	247
0017500000959	5	235	255
0017500000532	6	240	263
0017500000697	7	245	271
0017500000698	8	250	279
0017500000699	9	255	287
0017500000700	10	260	295
0017500000533	11	265	303
0017500000531	12	270	311
0017500000960	13	275	319
0017500000961	14	280	327

HEIGHT OF UPPER

Size of Footwear	Height (mm)
3	103-124
4	104-127
5	104-130
6	107 -133
7	110 -136
8	113 -139
9	116 - 142
10	119 -145
11	122 - 148
12	125 -151
13	128 -154
14	131 -157

MEASUREMENT OF TOE CAPS

Size of Footwear	Toe height	Inside height	Outside height	Width from max area	Minimum internal length (mm)
3	20	18	20	115	34
4	21	20	22	120	36
5	22	22	24	125	36
6	23	24	26	130	38
7	24	26	28	135	39
8	25	28	30	140	39
9	26	30	32	145	40
10	27	32	34	148	40
11	28	34	36	151	42
12	29	36	38	154	43
13	30	38	40	157	43
14	31	40	42	160	44

Note: Tolerance of ± 0.5 mm

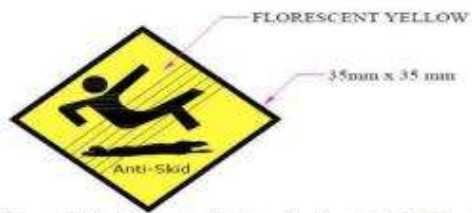

b. Amend Para 06 (e) of Annex B of PN Specification No 05/2017 as follows:

For:	Thickness	1.4 - 1.6mm
Read:	Thickness	0.9 - 1.1mm

c. Add in Para 23 of Annex B of PN Specification No 05/2017 as follows:

(e)	Inter Layer Bond Strength	Shall be not less than 4.0N/mm as per BS EN ISO 20345:2011
-----	---------------------------	--

5. Likewise following amendments/ addition in PN specification No 02/2015 (Anti-Static Shoes) may please be included at your end:

a. Add in Para 15 of PN Specification No 02/2015 as follows:

15.4 **Special Marking** Rubber patch shall be stitched in orange color on tongue of shoes as follows and embossing with **ANTI-STATIC** be done on outer side of quarter:

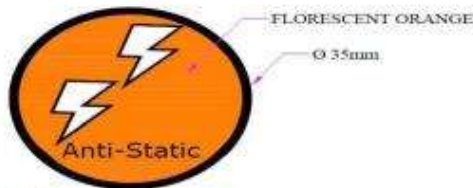

b. Amend Para 06 (e) of Annex B of PN Specification No 02/2015 as follows:

For:	Thickness	1.4 - 1.6mm
Read:	Thickness	0.9 - 1.1mm

c. Add in Para 22 of Annex B PN Specification No 02/2015 as follows:

Viewed by: Lt PN Rana Mehta, H...

(f)	Inter Layer Bond Strength	Shall be not less than 4.0N/mm as per BS EN ISO 20345:2011
-----	---------------------------	--

6. Letter at reference D may please be treated as cancelled.

ASMA SOHAIL
Lt Cdr PN
SO TEXTILE DITD (S)

Distribution:

External:

Action:

DP (NAVY)

CINS

DNS

CSD N

Attn: CO PNCSD

Information:

HQ COMLOG

Attn: SSO 5 TO COMLOG

COMDEP

Attn: SSO

Internal:

Information:

DNAI

PN/DGITD/03/993230 approved by SO TEXTILE DITD (S) Lt Cdr PN Asma Sohail on 13 Feb 2018

Note: Computer generated documents do not require signature

Viewed by: Lt PN Rana Mubhdli Hassan GO I PNCSD. Dated: 15 Nov 2021 15:17:30



DGITD
MATERIEL BRANCH
NAVAL HEADQUARTERS
NSSD AREA WEST
WHARF ROAD KARACHI

PN/DGITD/03/1496409

59256

See Distribution

15 January 2019

AMENDEMENT IN PN SPECIFICATION OF ANTISKID SHOES

Reference:

- A. PN/NS Dte/03/1280408 dated: 05 Sep 2018
- B. PN/MDITD/03/629197 dated: 04 May 2017
- C. DITD Contract TD/2400/10/Anitski/12/1683 dated 29 June 15

1. PN Specification of Anti Skid shoes was promulgated vide reference B. Now design of Antiskid shoes has been changed vide reference A. Accordingly measurement schedule, technical data and drawings attached as Annex A, B and C respectively, of PN Specification No. 05/2017 has been updated/ modified.
2. Foregoing in view, it is requested that amendment may please be incorporated in previous specification and compliance of the same may please be communicated by 18 Jan 19.

ASMA SOHAIL
Lt Cdr PN
SO TEXTILE DITD (S)

End(s):

1. Ammended Annexes A B and C of PN Spec 05 2017

Distribution:

External:

Viewed by: Lt PN Rana Mehdi Hassan GO I PNCSD/03/1496409/59256 No 2021 152015

Action:

DP (NAVY)

CINS

CSD N

Attn: CO PNCSD

Information:

DNS

HQ COMLOG

Attn: SSO S TO COMLOG

COMDEP

Attn: SSO

Internal:

Information:

DG ITD

PN/DGITD/03/1496409 approved by SO TEXTILE DITD (S) Lt Cdr PN Asma Sohail on 15 Jan 2019

Note: Computer generated documents do not require signature

Viewed by: Lt PN Rana Mehdi Hassan GO I PNCSD. Viewed: 15 Nov 2021 15:20:15

MEASUREMENTS AND DIMENSIONS

SIZE ROLL OF LAST MEASUREMENTS IN MILLIMETERS

SIZE OF FOOTWEAR	LENGTH ON SIZE STICK/ BOTTOM LENGTH
5	239 - 242
6	248 - 252
7	257 - 260
8	265 - 268
9	274 - 277
10	282 - 285
11	290 - 293
12	299 - 302
13	307 - 310
14	315 - 318

HEIGHT OF UPPER

SIZE OF FOOTWEAR	HEIGHT (mm)
5	194
6	197
7	200
8	203
9	206
10	209
11	212
12	215
13	218
14	221

Note: Tolerance of ± 05 mm.

ANNEX B TO
PN SPECIFICATION NO.05/2017
PROMULGATION DATE 04 MAY 2017

TECHNICAL DETAILS OF ANTI SKID SHOES

<u>S.NO</u>	<u>ITEM</u>	<u>REQUIREMENT</u>
<u>UPPER LEATHER (VAMP, COUNTER & EYELET FACING PUTTEE)</u>		
1.	Identification of leather	Cow full Grain plain
2.	Finish	Semi Aniline Finish
2.	Thickness	1.8 ~ 2.0 mm
3.	Softness	7.2 ~ 7.4 mm
4.	Chromium %	3.7 ~ 6.0%
5.	Shrinkage	3. % (Max)
6.	Tensile Strength	225 kg/cm ²
7.	Tear Strength (Kg/cm Thickness)	45 kg /cm thickness
8.	Dye fastness to Rubbing a. Dry (500 revs) b. Wet (50 revs)	GS 4 or better GS 4 or better
9.	Flexibility	No crack at 50,000 cycles
10.	Para-nitro Phenol	Shall be present
11.	Oil Repellency (Resistant to Liquid hydrocarbons) (UNE-EN ISO 14419:2000)	7
12.	Water Vapor Permeability (UNE-EN ISO 14268)	20 mg/cm ² .h (Min)
13.	Impermeability Water Dynamics (UNE EN ISO 5403:2003) a. Water Absorption at 2 h (%) b. Break through Time (min) c. Amplitude (%)	20 > 120 10
14.	Harmful Materials a. Azo Dyes b. Formaldehyde Content c. Chrome VI (UNE-EN ISO 17075: 2008)	Should not present Less than 22 mg/Kg Less than 3 ppm* *Component mg/ Kg Skin
15.	Shade	Black
16.	pH	Not less than 3.2 as per clause 5.4.7
<u>CLOTH CORDURA NYLON AT TONGUE AND VAMP WINDOW</u>		
1.	Material	Nylon
2.	Wt/Sq m	245 gms

3.	Weave	Plain
4.	Shrinkage	
	a. Warp	3.0%(MAX)
	b. Weft	3.0%(MAX)
5.	Linear Density	
	a. Warp	1000+100 Den
	b. Weft	1000+100 Den
6.	Breaking Strength (7.6 x 1.8 cm BG)	
	a. Warp	390+20 kg
	b. Weft	390+20 kg
7.	Washing Test	
	a. Change in Shade	GS 4 or better
	b. Staining on Cotton	GS 4 or better
	c. Staining on Nylon	GS 4 or better
8.	Shade	Black
9.	Nature of dye	Any Dye (Sulphur free)
10.	Water repellency Standard	Grade V

LINING AT VAMP & INTERLINING OF TONGUE AND QUARTER

1.	Material	Cotton (grey fabric)
2.	Weave	Drill
3.	Wt / Sq m	310 ± 5 grams
4.	Breaking Strength (10.2 x 16.8 cm BG)	
	a. Warp	200 ± 10 kg
	b. Weft	125 ± 5 kg
5.	Color	Black
6.	pH value	Not less than 3.2 as per clause 5.4.7
7.	Abrasion resistance	As per ISO 20345, clause 5.5.2
8.	Tear Strength	As per ISO 20345, clause 5.5.1

SAFETY TOE CAP

1.	Material	Steel free from burrs with anti rust coating
2.	Thickness	1.5 – 1.6 mm
3.	Internal length of toe cap	BS EN ISO 20345, 5.3.2.2

LINING AT QUARTER, COUNTER & TONGUE

1.	Material	100% Polyester
2.	Wt / Sq meter	180 ± 5 grams
3.	Thickness	4.5 – 5.0 mm
4.	Shade	Black
5.	Weave	Knitted

FOAMIC SHEET ON COLLAR, QUARTER AND TONGUE

1.	Material	Polyurethane (Open cell)
2.	Density	0.020 ± 0.005 g/cc
3.	Cell count (per linear 25 mm)	80-90
4.	Thickness	11 – 12 mm

EYELETS WITH SHANK AND CURVED WASHER

1.	Material	Brass
2.	Composition a. Copper b. Zinc	70% ± 5 30% ± 5
3.	Dia a. Inner b. Outer	6 ± 0.5 mm 10 ± 0.5 mm
4.	Coating	Powder Coated
5.	Colour	Black

LACES

1.	Material	Nylon 100%
2.	Construction	16 thread, 4 fold each multifilament
3.	Cross-Sectional Shape	Circular
4.	Nature of Dye	Any dye (Sulphur free)
5.	Dye Fastness to Washing	GS 4 or better
6.	Dye Fastness to Light	Class IV or better
7.	Breaking Strength (7" B.G)	75 kg (Min)
8.	Length with Tip	200 cm
9.	Tip a. Material b. Length	Plastic 1.5 ± 0.2 cm
10.	Color	Black
11.	Abrasion resistance	BS 953: 1979clause 8, not less than 11,000 cycles

ZIPPER MATERIAL SPECIFICATION

1.	Tape	Polyester 100%
2.	Elements	POM (Polyoxymethylene) Chips
3.	Zipper parts (Top Stop)	POM (Polyoxymethylene) Chips
4.	Zipper parts (Slider & Bottom Stop)	Zinc Alloy
5.	Chain width (mm)	7.40 (±0.18)
6.	Chain thickness (mm)	3.00 (±0.12)
7.	Element head (mm)	2.60 (±0.08)
8.	Element pitch (mm)	4.16 (±0.04)

9.	Bottom stop thickness (mm)	2.98 (± 0.08)
10.	Top stop thickness (mm)	3.00 (± 0.12)
11.	Total chain width (mm)	34.0 (± 0.08)
12.	Exposed tape width (mm)	13.3 (± 0.04)

ZIPPER PERFORMANCE TESTING

1.	Operating Force (N)	MAX 6.9
2.	Crosswise (N)	MIN 400
3.	Element slippage (N)	MIN 60
4.	Element pull-off (N)	MIN 70
5.	Folder cross wise(N)	MIN 150
6.	Top stop strength (N)	MIN 120
7.	Bottom stop holding strength (N)	MIN 120
8.	Slider lock strength 90°/45° (N)	MIN 50
9.	Slider lock strength 90°/45° (N)	MIN 170
10.	Durability (cycles)	500 cycles

INSOCKS

1.	Material	Closed cell foam laminated with knitted fabric
2.	Thickness (complete)	4.5 ~ 5.0 mm
3.	Foam Density	0.3 g/cc \pm 0.01g/cc
4.	Knitted Fabric a. Material b. Wt / Sq m c. Weave d. Shade	100% Polyester 180 \pm 5 gms Knitted Black
5.	pH value	Not less than 3.2
6.	Water absorption and desorption of insole as per BS EN ISO 20345:2011	Water absorption > 70 mg/cm ² Water desorption not less than 80 %
7.	Abrasion Resistance	As per BS EN ISO 20345, clause 5.7.4
8.	Hardness of socks	35-40 IRHD

INSOLE

1.	Material	Cellulose board like Texon or equivalent
----	----------	--

2.	Thickness	2.5 – 3.0 mm
3.	Split Tear	30 N / cm (Min)
4.	Flex Index	3.5 (Min)
5.	pH value	Not less than 3.2
6.	Water absorption and desorption of insole as per BS EN ISO 20345:2011	Water absorption > 70 mg/cm ² Water desorption not less than 80 %
7.	Abrasion Resistance	As per BS EN ISO 20345, clause 5.7.4

STITCHING THREAD

1.	Material	Nylon
2.	Construction	3 cord each multifilament
3.	Linear density	3/ 500 ± 30 Den
4.	Shade	Black
5.	Washing – 2 a. Change in shade b. Staining on Cotton c. Staining on Wool	GS 4 or better GS 4 or better GS 4 or better
6.	Dye Fastness to Light	Class IV or better
7.	Breaking Strength	6 kg/cm ² Min
8.	Nature of dye	Acid dye

COUNTERS STIFFENER

1.	Material	Non-woven thermoplastic (TP-8) or equivalent double face adhesive coated
2.	Thickness	2.0 mm (Min)
3.	Collapsing load(Dome test)	130.160 N (min)
4.	Extension at break	15-20%
5.	Shape retention	60-80% (min)
6.	Peel Strength	6N/cm (min)

OUTER SOLE

1.	Material	Nitrile Rubber
2.	Hardness	65 – 70 IRHD
3.	Abrasion (max)	130 mm ³
4.	Density	1.20 ± 0.05 g/cc
5.	Shade	Black
6.	Design	Chevron Tread
7.	Thickness	In accordance with table 17 BS EN ISO 20345
8.	Tread design	Cleats with Chevron design suitable for Anti-Skid requirement
9.	Cleat area	In accordance with BS EN ISO 20345, 5.8.1.2

10.	Cleat Height	In accordance with table 17 BS EN ISO 20345
11.	Resistance to hot contact	BS EN ISO 20345:2011, clause 6.4.1
12.	Sole of the shoes is resistant to fuel& oil	BS EN ISO 20345:2011, clause 6.4.2.
<u>MID SOLE</u>		
1.	Material	PU Polyether Direct Injection on DESMA Machine
2.	Hardness	55 - 60 IRHD
3.	Density	0.45 ± g/cc
4.	Shade	Black
5.	Non-metallic anti-penetration insert	Kevlar
6.	Non-metallic anti-penetration insert	BS EN ISO 20344:2011,5.8.3, no nail should protrude from the sample
<u>PERFORMANCE TEST OF WHOLE SHOE</u>		
1.	Water Resistivity*	Boot should be water resistant for min 30 x minutes
2.	Identification of Leather	Cow Full Grain
3.	Flexing/ Cracking of upper & Sole	No damage less than 80,000 cycles
	a. Toe Cap (i) Impact resistance of safety footwear (ii) Compression resistance of safety footwear (iii) Corrosion resistance of metallic toe cap b. Specific ergonomic feature c. Slip resistance requirement e. Water resistance	Impact of 200 J clearance under toe cap in accordance with table 6 of BS EN ISO 20345 Compression load of 15 KN clearance under toe cap in accordance with table 6 of BS EN ISO 20345 Not more than three areas of corrosion measuring not more than 2 mm in any direction BS EN ISO 20345, clause 5.3.4 In accordance with BS EN ISO 20345, clause 5.3.5.4 And In accordance with STM 144 Steel Floor (Dry) Heel : 0.6 Toe : 0.6 Steel Floor (Water) Heel : 0.4 Toe : 0.4 As per BS EN ISO 20345, clause 6.2.5
4.	Height of Upper (Length of Leg)	Length of leg when lasted shall not be less than 203 mm (8 inches) for size – 8. Whereas; other sizes increasing or decreasing by approx. 3mm from size to size.
5.	Stitch / 25 mm	7-8
6.	Thickness of Sole for size 8	
	a. At Toe b. At Heel	30 mm (increase and decrease with increment or 49 mm decrement in size)

7.	Bond Test (ISO 20346:2004 (E) and ISO 20344:2004)	The bond strength shall not be less than 4.0 N/mm. Unless there is tearing of the Sole, in which case the bond shall not be less than 3.0 N/mm
8.	Seepage Test **	No staining/ seepage of water through upper seams
9.	Shade	Black

SEAM FILLER

1.	Paraffin Wax	30 %
2.	Stearic Acid	30 %
3.	Solvent Oil	40 %

Note:

***Water resistivity** A pair of white cotton socks of an appropriate size properly stuffed with pieces of cloth shall be inserted in the boot. The boot shall then be immersed in water containing a water level upto lower edge of third speed lacing hook from top. Boot tested should not show signs of wetting on sock/seepage of water at interval of 30min.

****Seepage Test** A pair of white cotton socks of an appropriate size properly stuffed with pieces of cloth shall be inserted in the boot. The boot shall then be immersed in water containing water soluble dye for 2 min. Boot shall be immersed above the sole / heel height and be flexed twice at interval of 30 sec. Not more than 5% of boot tested should show signs of staining on socks/ seepage of water through upper seams.

ANNEX C TO
PN SPECIFICATION NO. 05/2017
PROMULGATION DATE 04 May 2017

DRAWING OF ANTISKID SHOES AND PACKING

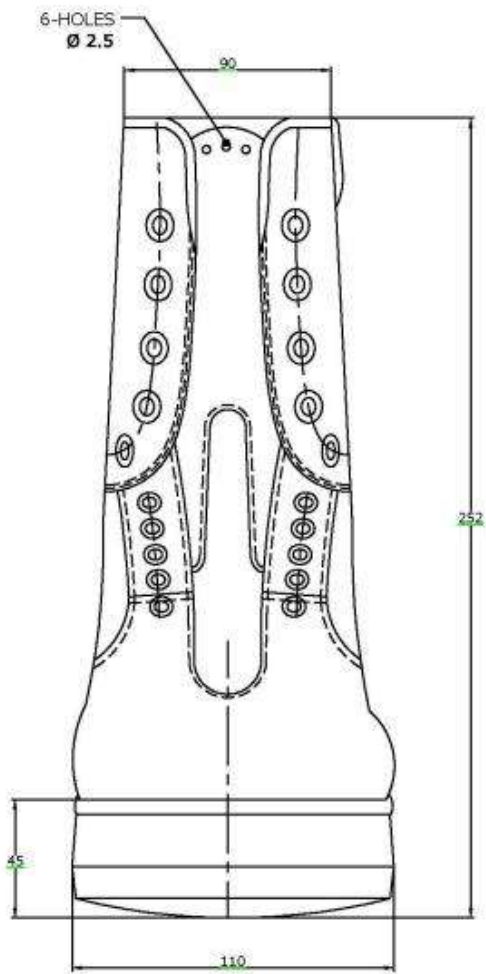

FRONT VIEW

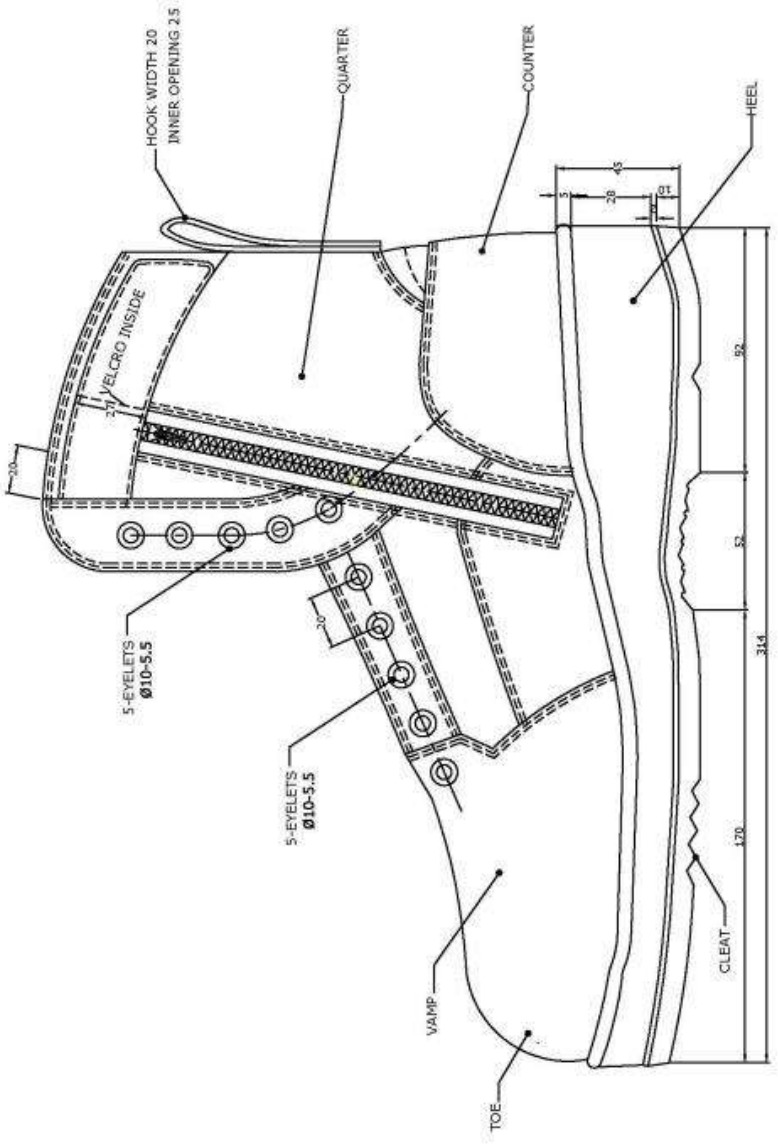

LEFT SIDE VIEW

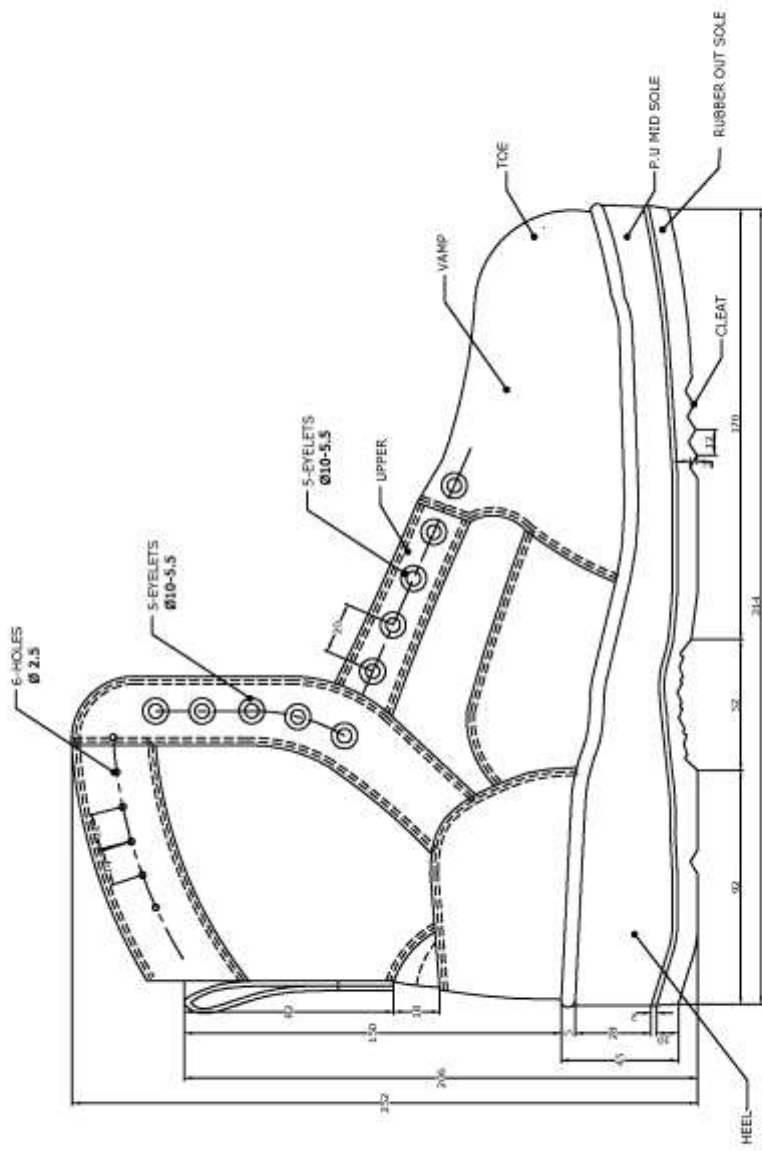

RIGHT SIDE VIEW

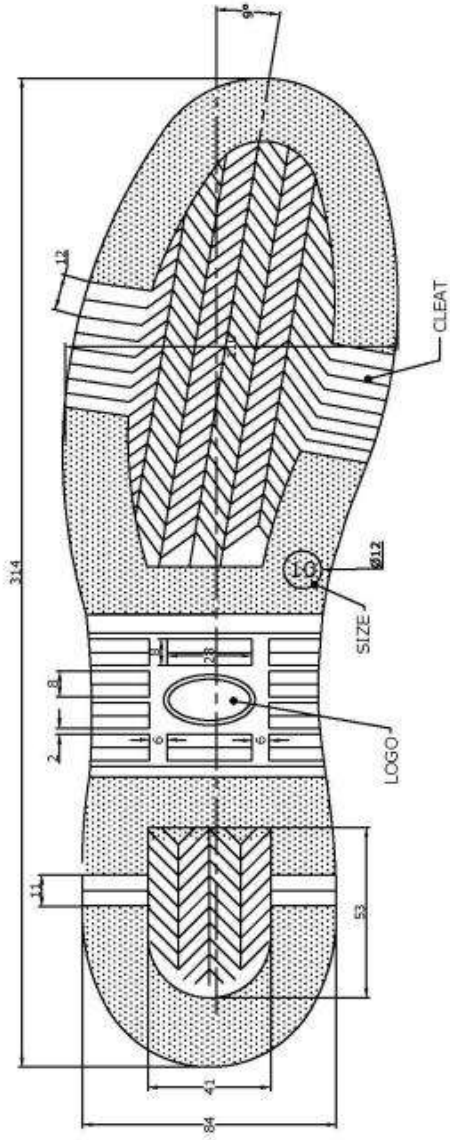

BOTTOM VIEW

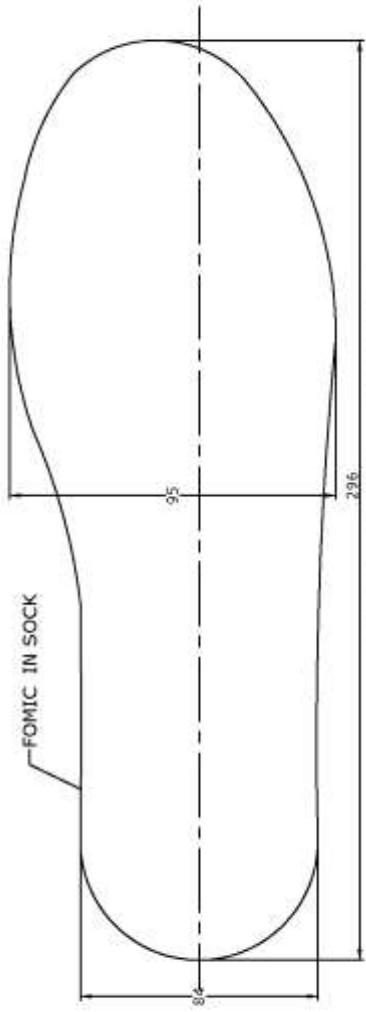

IN SOCK BOTTOM VIEW



IN SOCK SIDE VIEW

2/5

Shoes Black Leather (Safety Boot Antiskid Black) Size 10



Shoes Black Leather (Safety Boot Antiskid Black) Size 11



Shoes Black Leather (Safety Boot Antiskid Black) Size 10



Shoes Black Leather (Safety Boot Antiskid Black) Size 11



Shoes Black Leather (Safety Boot Antiskid Black) Size 10



Shoes Black Leather (Safety Boot Antiskid Black) Size 11



Shoes Black Leather (Safety Boot Antiskid Black) Size 10



Shoes Black Leather (Safety Boot Antiskid Black) Size 11



Shoes Black Leather (Safety Boot Antiskid Black) Size 10



Shoes Black Leather (Safety Boot Antiskid Black) Size 11



Shoes Black Leather (Safety Boot Antiskid Black) Size 10



Shoes Black Leather (Safety Boot Antiskid Black) Size 11



Shoes Black Leather (Safety Boot Antiskid Black) Size 10



Shoes Black Leather (Safety Boot Antiskid Black) Size 11



Shoes Black Leather (Safety Boot Antiskid Black) Size 10



Shoes Black Leather (Safety Boot Antiskid Black) Size 11



Shoes Black Leather (Safety Boot Antiskid Black) Size 10



Shoes Black Leather (Safety Boot Antiskid Black) Size 11



2/11

Shoes Black Leather (Safety Boot Antiskid Black) Size 8



Shoes Black Leather (Safety Boot Antiskid Black) Size 8



Shoes Black Leather (Safety Boot Antiskid Black) Size 8



Shoes Black Leather (Safety Boot Antiskid Black) Size 8



Shoes Black Leather (Safety Boot Antiskid Black) Size 8



Shoes Black Leather (Safety Boot Antiskid Black) Size 8



Shoes Black Leather (Safety Boot Antiskid Black) Size 8



Shoes Black Leather (Safety Boot Antiskid Black) Size 8



Shoes Black Leather (Safety Boot Antiskid Black) Size 8



Shoes Black Leather (Safety Boot Antiskid Black) Size 9



Shoes Black Leather (Safety Boot Antiskid Black) Size 9



Shoes Black Leather (Safety Boot Antiskid Black) Size 9



Shoes Black Leather (Safety Boot Antiskid Black) Size 9



Shoes Black Leather (Safety Boot Antiskid Black) Size 9



Shoes Black Leather (Safety Boot Antiskid Black) Size 9



Shoes Black Leather (Safety Boot Antiskid Black) Size 9



Shoes Black Leather (Safety Boot Antiskid Black) Size 9



Shoes Black Leather (Safety Boot Antiskid Black) Size 9





PN SPECIFICATION NO 05 /2017

PAKISTAN NAVY SPECIFICATION 05/2017

PROMULGATION DATE: 04 May 2017

SHOES ANTI-SKID

Prepared by:

Directorate of Indigenous
Technical Development
at NSSD, West Wharf Road
KARACHI
Tel: 021 48508410
Fax: 021 99214765

AMENDMENT RECORD

Amd No	Date	Text Effected	Signature and Date

REVISION NOTE

The specification has been prepared to bring the test methods and procedures into line with up-to-date PN requirements and facilities held in Pakistan. CINS may request to amend any test requirement/ test procedure in light of the experience emanating from its inspection history, through the feedback form placed at Annex F. However, such an alternation will be effective when the amendment is promulgated by this Directorate, and will be effective on the contracts which materialize after the promulgation date of respective amendment.

CONTENTS

<u>Description</u>	<u>Page</u>
Contents	03
<u>Details</u>	
Designation	04
Usage	04
Introduction	04
Scope	04
Related Documents	04
Terms & Definitions	04
Technical Details	05
Manufacturing Details	05
Quality of Workmanship and finishing	06
Testing	07
Tender Sample	07
Advance Sample	07
Inspection	08
Stamping of Accepted/Rejected Stores by Inspector	09
Special Instruction	09
Packing Details	10
Identification Label	10
Packing List	10
Marking of Stores	10
Delivery	11
<u>Annexes:</u>	
A. Measurements and Dimensions	12
B. Technical Details of Shoes Anti-Skid	14
C. Drawings of Anti-Skid Shoes and Packing	17
D. Terms & Definitions	20
E. Guideline for Inspection –General Defects	21
F. Feed Back Form	23

1. **DESIGNATION**

1.1 Shoes Anti-Skid

2. **USAGE**

2.1 These shoes will be used by Military and civilian personnel in designated areas on land and onboard ships, where a level of toe protection and slip/skid resistance is deemed necessary.

3. **INTRODUCTION**

3.1 This specification is prepared by Directorate of Indigenous Technical Development, Karachi, to provide necessary guidance to the potential manufacturers/ suppliers of the items mentioned herein. This specification is to be used for testing and deciding upon acceptance, or otherwise, of the items mentioned. Any alteration or addition in this specification can be suggested to ITD Directorate. However, it cannot be implemented without prior approval of DITD. This specification supersedes and replaces PN Specification PN/UNIFORM/01/2003 promulgated on 01 Mar 2003 earlier in relation to the item mentioned herein. These specifications are based on newly developed and accepted Anti-Skid shoes at ITD Organization.

3.2 This specification booklet includes 06 Annexes and consists 22 pages, including the cover.

4. **SCOPE**

4.1 This specification covers the manufacturing / inspection requirements of Shoes Anti-Skid to be used by Pakistan Navy. This specification lays down the standard to which the stores shown under designation above should conform. It defines and lays down the quality, standard and details of materials, workmanship and finish. It also lays down the details of sampling, testing, inspection rejection, marking, preservation, packing and delivery etc.

4.2 The supplier/ manufacturer shall comply in every respect with the terms of this specification and ensure that the stores conform to it, in all respects.

5. **RELATED DOCUMENTS**

5.1 The standards and documents that have been referred to in this specification are:

- | | | |
|----|----------------------|--|
| a. | BS EN ISO 20345:2011 | Personal Protective equipment – Safety footwear. |
| b. | BS EN ISO 20344:2011 | Personal Protective equipment – Test methods for footwear. |
| c. | AATCC-20 | Determination of fiber quality. |
| d. | ASTM E- 478 | Standard test method for chemical analysis of Copper alloys. |
| e. | D2240-04 | Test method for Rubber Property- Durometer Hardness. |
| f. | BS ISO 1817 | Rubber Vulcanized. Determination of the effect of liquid. |
| g. | SATRA TM 92 | Resistance of footwear to flexing. |
| h. | SATRA STD 185 | Sole Adhesion tester. |
| j. | SATRA TM77 | Flexing Machine- Water Penetration test. |

6. **TERMS & DEFINITIONS**

6.1 Definitions for the terms used in this standard are given at Annex D of this specification.

SPECIFIC REQUIREMENTS

7. TECHNICAL DETAILS FOR SHOES ANTI-SKID

7.1 The Technical Details of Anti-Skid shoes are mentioned at Annex B of this specification.

8. MANUFACTURING DETAILS FOR SHOES ANTI-SKID

8.1 LAST

8.2 All sizes of last should be equal to the one mentioned at Annex A to this specification. While manufacturing the shoes a hard material of 3.2 mm thick is to be added on the bottom of the last in order to provide a space for inserting a detachable sock.

8.3 The suppliers/ manufacturer must intimate the size roll of the last/ moulding foot in their possession conforming to the specified particulars and must get representative samples approved by the Inspecting Authority before commencing manufacture.

8.4 Details of dimensions of the specified last of various sizes i.e. from 03 to 11 are given in the Annex A of this specification.

8.5 CONSTRUCTION

8.6 The construction of the shoes shall be by Direct Injection Rubber and PU with the upper. The shoes shall be supplied in various sizes as mentioned at Annex A of this specification.

8.7 Measurement details of height of upper are indicated as Annex A of this specification.

8.8 The Toe cap shall be incorporated in the footwear in such a manner that they cannot be removed without damaging the footwear. Toe cap shall be as per dimension mentioned at Annex A to this specification. The toe cap shall have an edge covering with EVA (Ethyl Vinyl Acetate) foam strip for safety and comfort purposes and embossed with standard EN 12568.

8.9 Leather used in making upper shall be of good quality full Chrome Cow Leather and should be suitable for very hard wear. The minimum thickness of various components of upper should be as that mentioned in Annex B of this specifications.

8.10 Lining used in vamp shall be of drill cloth and are bonded to the steel toe cap which is to be backed with EVA foam strip to meet safety and comfort requirements. The lining should satisfactorily withstand the moulding temperature on operations.

8.11 The tongue should be padded with compressible material, such as sponge, rubber or felt, the compressible material should be enclosed in a pocket between the tongue itself and knitted polyester lining such that the total thickness should not be less than 3.4 mm (0.12 inch). The padding should not be less than 55/8inchlong and 36/8 inch wide from top and 2 1/8inchfrombottom, except near the top where it is to be rounded off (tolerance $\pm 2\%$).

8.12 Good quality Nylon laces with plastic tip should be used.

8.13 Insole should be permanently attached and it shall not be possible to remove it without damaging the footwear. Full socks made up of EVA sheet covered with knitted polyester cloth, which could be detachable and washable.

8.14 All seams should be properly hammered off and all loose ends secured properly.

- 8.15 The upper components shall be properly skived and fitted. Skiving on the grain side is prohibited.
- 8.16 The upper components shall be closed by lock stitching.
- 8.17 The Vamp shall be joined with quarter and tongue with four rows of stitching 1.5 mm apart and number of stitches per inch (25.4) mm shall be 6-7 with ± 1 tolerance along-with the suitable binding material.
- 8.18 The counter shall be stitched with four rows of stitching 1.5 mm apart and no. of stitches per inch (25 mm) shall be 6-7 in number with ± 1 tolerance.
- 8.19 The number of stitches per inch (25 mm) shall be 6-7 in numbers at the back seam which shall be stitched, taped and again stitched with single row of stitching on either side.
- 8.20 Six pairs of Eyelets Brass Black shall be fitted on each side / facing which will clinch properly without being distorted or de-shaped. The eyelets shall be spaced equidistant at 22 mm. First eyelet being 19 mm from top of the edge of the quarter and 16 mm away from the edge of the facing, distance between eyelets are shown at Annex C of this specification.
- 8.21 The counter stiffeners shall be skived properly so that no ridge is formed in the finished Shoes. They shall be reinforced and made hard.
- 8.22 The insole shall be properly feathered, snuffed and moulded to the bottom shape (contour) of the last.
- 8.23 The shoes shall remain on the last at least for 24 Hours.
- 8.24 The vulcanization of sole to the upper shall be done by high-pressure type Moulding Machine, provided with the thermo-regulate heater in bottom and the two side moulds. Pressure control/gauge and auto time controlling devices. A piece of compounded Rubber cut to the approximate shape of the sole and correct height for the size of the Mould known as sole Mould in the machine. The Blank may be pre-heated in a cabinet upto desired temperature immediately before moulding.
- 8.25 Flash and spew on edge of the moulding last and the surplus material on the sole and heel shall be properly trimmed off/removed.
- 8.26 A Spare pair of laces round Nylon with plastic tip 50 inch shall be supplied with each pair of Shoes. Finish of tips shall be good.
- 8.27 The midsole is bonded with the outer sole by using any suitable adhesive, reinforced with textile, to improve bonding quality, loose bonding sample should be rejected.

Note: Usage of nails in manufacturing of Anti-skid shoes shall be strictly prohibited.

9. QUALITY OF WORKMANSHIP AND FINISHING

- 9.1 Workmanship and finish of the shoes shall be equal to the sealed sample. It shall be best of its class and to the entire satisfaction of the inspector.

10. TESTING

10.1 The material shall be subjected to tests laid down in this specification at Annex B of this specification and related documents. At least two pair of shoes of same or different sizes will be required to complete relevant test mentioned at Annex B of this specification. The material may also be subjected to such tests which are deemed necessary by the inspection authority in order to determine their suitability. Inspecting Authority reserves the right to get the B/R samples tested from any reputable Laboratory other than PN. Test mentioned at Annex B are depicted mostly from BS EN ISO 20345: 2011. However, any test considered important by Inspecting Authority other than Annex B may also be conducted from BS EN ISO 20345.

11. TENDER SAMPLE

11.1 Tender sample to be approved by INS

11.2 For each contract following material shall be supplied by the manufacturer at the time of tendering.

i.	Shoes (Anti Skid)	05 in No.(two different sizes)
ii.	Manufacturing last	One pair
iii.	Pattern (cut component complete set)	One set of same size
iv.	Leather for uppers	1' x 1' (02 pieces)
v.	Thread for upper closing	50 gms
vi.	Eyelets	06 in number
vii.	Steel toe cap	02 Pairs (two different sizes)
viii.	Laces	02 in Nos.
ix.	Lining Material	02 meters
x.	Binding adhesive	0.5 Kg.
xi.	Padding material	1' X 1'
xii.	Sole	02 Pairs (two different sizes)
xiii.	Socks	02 Pairs (two different sizes)

12. ADVANCE SAMPLE

12.1 Advance sample or pre-production sample, when required, shall be submitted in accordance with terms of the contract for inspection, testing as per para 7 and 8 above and approved by CINS. The minimum quantities required are 05 pairs alongwith samples of materials used in manufacturing of antiskid shoes for inspection.

12.2 Whenever Tender, Advance or pre-production sample is not required, the suppliers / manufacturer are advised in their own interest to submit to the Inspecting Officer or his representative an initial delivery of One % of the contract or ten pairs, whichever are more alongwith samples of materials for inspection.

12.3 The approval of the sample mentioned in Para 11 & 12 authorizes the commencement of bulk production but does not relieve the suppliers/ manufactures from compliance with all the provisions of this specification. One approved sample shall be properly sealed by INS and returned to the firm for guidance; rest of the approved sample shall be retained by INS for future use in bulk inspection.

12.4 The Pre-production sample shall be manufactured by the manufacturer with the same facilitates which will be used for manufacture of the bulk items.

12.5 Firm shall provide advance sample along with quality verification reports of shoes from an accredited laboratory.

13 **INSPECTION**

13.1 **Bulk representative sample** B/R random sampling will be carried out as per rules in vogue.

13.2 **Bulk Inspection** Bulk inspection will be carried out after satisfactory completion of Visual Examination and Testing of B/R Sample as per para 7 and 8 above.

13.3 **Inspection of Shoes** 100% of the offered store shall be inspected. The guide lines for such examination/inspection are listed at Annex E. Stage inspection of anti-skid shoes may be carried out by CNS if deemed necessary.

13.4 **Inspection/ Acceptance and Rejection of Stores** Inspection/ acceptance is to be carried out to the satisfaction of Chief Inspector Naval Stores.

13.5 The shoes shall be examined for the correctness of material, shape, design, dimension, size, workmanship and finish.

13.6 All shoes shall be inspected in pairs and shall be accepted and rejected as pairs. Defective lasting, mouldings and damages to upper and insoles during moulding are to be especially checked.

13.7 CNS reserves the right to reject the whole supply in case, upon examination, material or packing of any sample or portion of the consignment is found NOT CONFORMING to this specification.

13.8 If on examination of 5% of any delivery, 20% of those examined from bulk supply are found NOT CONFORMING to this specification in respect of the material, pattern, dimensions, workmanship and finish, the whole consignment may be rejected without any compromise.

13.9 All stores and packing NOT fully in accordance with this specification shall be rejected.

13.10 Shoes with major defects as described in Annex E of this specification will be rejected.

13.11 **Responsibility for Inspection** The supplier is responsible for the performance of all inspection requirements (examinations and tests) as specified herein. PN reserves the right to perform any of the inspections set forth in the specification where such inspections are deemed necessary to ensure supplies and services conform to prescribed requirements.

13.12. **Responsibility for Compliance** The inspection set forth in this specification shall become a part of the supplier's overall inspection system or quality program. The absence of any inspection requirements in the specification shall not relieve the contractor of the responsibility of ensuring that all products or supplies submitted to PN for acceptance comply with all requirements of the contract. Sampling inspection, as part of manufacturing operations, is an acceptable practice to ascertain conformance to requirements, however, this does not authorize submission of known defective material, either indicated or actual, nor does it commit PN to acceptance of defective stores (material).

13.13 **Replacement by the Contractor** The supplier manufacture is responsible for replacement of the consignment or any part thereof whenever it is found to be not conforming

to this specification. The supplies so tendered in replacement, shall be subjected to testing/inspection and acceptance by the Inspecting Officer.

13.14 **Responsibility for Safety** The supplier/manufacturer is wholly responsible for the safety of supplies during inspection, storage at firm's premises, proper packing, dispatch and delivery up to consignee.

14 **STAMPING OF ACCEPTED/ REJECTED STORES BY THE INSPECTOR** Following instructions are to be followed:

14.1 **Stamping of Accepted Stores** The acceptable shoes shall be stamped with Inspector's Individual Acceptance Mark's. The stamping shall be legible.

14.2 **Stamping of Rejected Stores** The rejected shoes shall be marked with Inspector's Rejection Mark's to avoid re-submission by the supplier.

14.3 The Inspector is the authority in all matters pertaining to inspection.

15 **SPECIAL INSTRUCTIONS**

15.1 **CARE LABEL INSTRUCTIONS** Shoes Anti-skid are capable of being cleaned by using conventional means to maintain smart & functional appearance. Following care instructions in the form of leaflet shall be provided in English and Urdu with each pair of shoe:

- Clean the shoes with a damp cloth using a solution of water and mild soap.
- To extend the life and maintain suppleness of the upper apply a shoe care product appropriate to the upper.
- The sole of shoes shall be cleaned frequently when feel necessary using conventional means to maintain smart and functional appearance.

Note: Firm shall provide usage warranty of one year at the time of inspection.

15.2 **PACKING/ STORAGE INSTRUCTIONS** Polyurethane are prone to degradation due to Hydrolysis damage when they are stored in warm, moist conditions for long period. Firm will ensure adequate storage by providing preferably silica gel bags and holes in the box of each pair of shoe or by any other means upto the satisfaction of inspecting authority. Following packing/ storage instructions shall be provided in English as well as Urdu with the packing list during inspection and with each pair of shoes in the form of leaflet for convenience of Depots and end user:

- Store in a dry and well-ventilated area.
- Frequent usage actually prolongs the life of Anti-Skid shoes.
- Use of poly bags for storage of shoes shall be prohibited.
- In ware houses storage of Polyurethane (PU) soled shoes at higher temperature will shorten the overall storage life of the product. It is recommended that PU sole Antiskid Shoes are stored at temperature below 30°C and at low level humidity.

Note: Firm shall provide a shelf life certificate for a period of 4 years at the time of inspection.

16. **PACKING DETAILS** The store when ordered to be delivered 'PACKED' shall be packed as follows:

- The pair of shoes shall be packed in a neat, dry and clean condition in standard packaging card board box as per drawing at Annex C.
- Ten pairs Shoes of one size only shall be packed in a thick Boxboard/Flouring. Packing of mixed sizes shall be avoided and shall not be normally permitted.
- The empty spaces if any shall be filled with suitable cushioning materials.
- Strapping shall be done in accordance with the instruction of Inspecting officer.
- The total weight of package shall not exceed 35kg.
- Each Box Board packing shall be securely and properly packed.

17. **IDENTIFICATION LABEL** Each shoe shall bear the following information on Main Label attached on inside edge of collar, as indicated in the drawing at Annex C of this specification:

- a. Item name/ Item description with size and NSN No.
- b. Contract number and Date.
- c. Year of manufacture.
- d. Contractor's name, initials, or trade mark.
- e. Batch no.
- f. Symbol of appropriate protection provided.
- g. Reference of International standard ISO 20345:2011.

18. **CERTIFICATION** Firm will provide hydrolysis certification of poly urethane from BASF.

19. **PACKING LIST** Firm is bound to provide a packing list of store offered for inspection alongwith the challan, which include complete details about the store i.e Pattern No. Designation, quality packed, size, quantity, contract No, and Date, Challan No. and Date. A packing list shall be enclosed after completion of inspection with each packed box giving full details about the stores packed i.e. Pattern No. Designation, quality packed, size, quantity, contract No, and Date, I/Note No. or voucher No. and date, consignee, Consignor, Date of packing and packer's signature.

20. **MARKING OF STORES** In addition to any special marking required by contract or order, the marking of packages shall be stenciled with quick drying Black ink/ Paint in accordance with Specification No. NS/MISC/002/80with clearly defined characters as described below:

- a. On Front and Top
 - (1) Catalogue No and Designation of the store packed.
 - (2) Contract No and date.
 - (3) Quantity of the Item packed.
- b. On Back
 - (1) Consignee address.
 - (2) Designation i.e Railway Station.
 - (3) Weight of the Package.
 - (4) The No. of individual Package and the total No of Packages in the consignment joined by the Word 'of 'e.g. 2 of 300.
- c. On Bottom
 - (1) Consignor's Name.
 - (2) Voucher No. or inspection note no. and date.
 - (3) Month and year of packing.

21. **DELIVERY**

21.1 The consignment of store will be delivered in accordance with the terms of contract.

21.2 The store shall be delivered in Brand new, clean and dry condition.

21.3 The contractor / manufacturer is fully responsible for the safety of the supplies during inspection, storage at firms premises proper packing, dispatch and delivery up to consignee.

xxxxSDxxx
IJAZ AHMAD
Captain Pakistan Navy
Director

Annexes:

- A. Measurements and Dimensions
- B. Technical Details of Shoes Anti-Skid
- C. Drawings of Shoes Anti-Skid and Packing
- D. Terms & Definitions
- E. Guideline for Inspection – Specific Parts Defects
- F. Feed Back Form

Distribution:

DNS

DP (N)

CINS

CO PNCSD

MEASUREMENTS AND DIMENSIONS

SIZE ROLL OF LAST MEASUREMENTS IN MILLIMETERS

NSN / Pattern No.	SIZE OF FOOTWEAR	GIRTH	LENGTH ON SIZE STICK/ BOTTOM LENGTH
0017500000962	3	225	239
0017500000958	4	230	247
0017500000959	5	235	255
8430505000919	6	240	263
8430505000915	7	245	271
8430505000916	8	250	279
8430505000917	9	255	287
8430505000918	10	260	295
8430505000920	11	265	303

HEIGHT OF UPPER

SIZE OF FOOTWEAR	HEIGHT (mm)
3	103-124
4	104-127
5	104-130
6	107 -133
7	110 -136
8	113 -139
9	116 - 142
10	119 -145
11	122 - 148

MEASUREMENT OF TOE CAPS

SIZE OF FOOTWEAR	TOE HEIGHT	OUTSIDE HEIGHT	INSIDE HEIGHT	WIDTH FROM MAX AREA	MINIMUM INTERNAL LENGTH (mm)
3	20	18	20	115	34
4	21	20	22	120	36
5	22	22	24	125	36
6	23	24	26	130	38
7	24	26	28	135	39
8	25	28	30	140	39
9	26	30	32	145	40
10	27	32	34	148	40
11	28	34	36	151	42

Note: Tolerance of ± 0.5 mm

TECHNICAL DETAILS FOR SHOES ANTI-SKID

S NO	ITEM	REQUIREMENT
	MATERIAL SPECIFICATIONS	
01.	Classification	Class 1 of BS EN ISO 20345
02.	Design	B (Ankle Boot) of BS EN ISO 20345
03.	Color	Black
04.	Weight per pair of shoe	1500-1800 gms
05.	Height of Upper	As per Annex B of this specs measured as per BS EN ISO 20345, 5.2.2
06.	<u>Upper</u>	
	(a) Vamp	
	i. Material	Cow Full Grain Leather
	ii. Thickness	1.6 – 1.8 mm
	(b) Quarter	
	i. Material	Cow Full Grain Leather
	ii. Thickness	1.6 – 1.8 mm
	(c) Counter	
	i. Material	Cow Full Grain Leather
	ii. Thickness	1.4 – 1.6 mm
	(d) Tongue	
	i. Material	Cow leather
	ii. Thickness	1.0-1.10mm
	(e) Collar	
	i. Material	Cow Leather
	ii. Thickness	1.4 – 1.6 mm
07.	<u>Padding</u>	
	(a) Tongue	
	i. Material	Foam
	ii. Thickness	3-4 mm (min)
	(b) Collar	
	i. Material	Foam with EVA sheet
	ii. Thickness	5-6 mm (foam) 1.63 (EVA)
08.	<u>Lining Material</u>	
	(a) Vamp	
	i. Material	Fabric drill cloth (Color off White)
	ii. Weight/sq meter	310 gms
	(b) Quarter	
	i. Material	Knitted polyester lining
	(c) Tongue	
	i. Material	Goat leather
	ii. Thickness	0.7-0.9
09.	Socks	
	i. Material	EVA Black with black knitted polyester fabric lining on top

PN SPECIFICATION NO 05 /2017

	ii. Thickness	Design as per drawing at Annex B of this specifications
10.	Counter Stiffener i. Material ii. Thickness	Thermoplastic 1.4 mm
11.	Safety toe Cap i. Material ii. Thickness iii. Internal length of toe cap	Steel free from burrs with anti rust coating 1.5 – 1.6 mm Annex C of this specs BS EN ISO 20345, 5.3.2.2
12.	Stitching Thread i. Material ii. Count	Nylon 50/3
13.	Eyelets i. Material ii. Diameter	Brass Black 5 mm
14.	Laces i. Material ii. Length iii. Diameter	Round Nylon with plastic tip of 13 mm 50" 3-4 mm
15	Insole i. Material ii. Thickness	Non-Woven cellular fibre board 2.5 – 3.0 mm
16.	Mid-Sole i. Material ii. Thickness iii. Density	PU As per attached drawings of this specifications 0.45±0.03
17.	Outer Sole i. Material ii. Thickness iii. Tread design iv. Cleat area v. Cleat Height	Nitrile Rubber In accordance with table 17 BS EN ISO 20345 Cleats with Chevron design suitable for Anti-Skid requirement In accordance with BS EN ISO 20345, 5.8.1.2 In accordance with table 17 BS EN ISO 20345
18	Non-metallic anti-penetration insert	Kevlar
PERFORMANCE TESTING		
19.	<u>Whole footwear</u> a. Toe Cap (i) Impact resistance of safety footwear (ii) Compression resistance of safety footwear (iii) Corrosion resistance of metallic toe cap	Impact of 200 J clearance under toe cap in accordance with table 6 of BS EN ISO 20345 Compression load of 15 KN clearance under toe cap in accordance with table 6 of BS EN ISO 20345 Not more than three areas of corrosion

PN SPECIFICATION NO 05 /2017

	<p>b. Specific ergonomic feature</p> <p>c. Slip resistance requirement</p> <p>d. Flexing Resistance after 80,000 cycles</p> <p>e. Water resistance</p>	<p>measuring not more than 2 mm in any direction BS EN ISO 20345, clause 5.3.4</p> <p>In accordance with BS EN ISO 20345, clause 5.3.5.4 And In accordance with STM 144 Steel Floor (Dry) Heel : 0.6 Toe : 0.6 Steel Floor (Water) Heel : 0.4 Toe : 0.4</p> <p>No cracks observed on upper and sole As per BS EN ISO 20345, clause 6.2.5</p>
20.	<p>Upper</p> <p>(a) pH value</p> <p>(b) Chromium VI content</p> <p>(c) Tear Strength</p> <p>(d) Tensile Strength</p> <p>(e) Circular rub fastness test</p>	<p>Not less than 3.2 as per clause 5.4.7 Not exceeding 3.0 mg/kg, as per 5.4.9 As per BS EN ISO 20345, as per 5.4.3 As per BS EN ISO 20345, as per 5.4.4 No damage of leather and staining of dry felt for wet felt GS 4 after 50 cycles in wet and dry conditions</p>
21.	<p>Vamp And Quarter Lining</p> <p>(a) pH value</p> <p>(b) Abrasion resistance</p> <p>(c) Tear Strength</p>	<p>Not less than 3.2 as per clause 5.4.7 As per ISO 20345, clause 5.5.2 As per ISO 20345, clause 5.5.1</p>
22.	<p>Insole and In sock</p> <p>(a) pH value</p> <p>(b) Water absorption and desorption of insole As per BS EN ISO 20345:2011</p> <p>(c) Abrasion Resistance</p> <p>(d) Hardness of socks</p>	<p>Not less than 3.2 Water absorption > 70 mg/cm² Water desorption not less than 80 % As per BS EN ISO 20345, clause 5.7.4 35-40 IRHD</p>
23.	<p>Out Sole</p> <p>(a) Upper/outsole Bond Strength At Toe At Heel</p> <p>(b) Hardness Outer Rubber Sole PU Mid sole</p> <p>(c) Resistance to hot contact</p> <p>(d) Sole of the shoes is resistant to fuel& oil</p>	<p>25 kg Minimum 39 kg Minimum</p> <p>65 -70 IRHD 55 - 60 IRHD</p> <p>BS EN ISO 20345:2011, clause 6.4.1 BS EN ISO 20345:2011, clause 6.4.2.</p>
24.	<p>Laces</p> <p>(a) Abrasion resistance</p> <p>(b) Tensile strength</p>	<p>BS 953: 1979 clause 8, not less than 11,000 cycles BS 5131: Section 3.7, not less than 500N.</p>
25	<p>Non-metallic anti-penetration insert</p>	<p>BS EN ISO 20344:2011,5.8.3, no nail should protrude from the sample</p>

ANNEX C TO
PN SPECIFICATION NO 05/2017
PROMULGATION DATE 04 MAY 2017

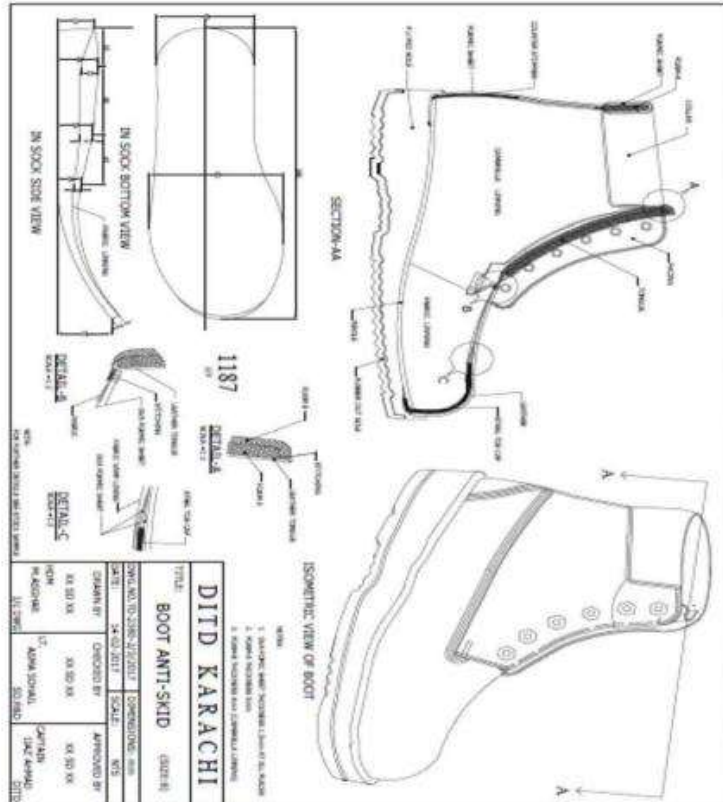

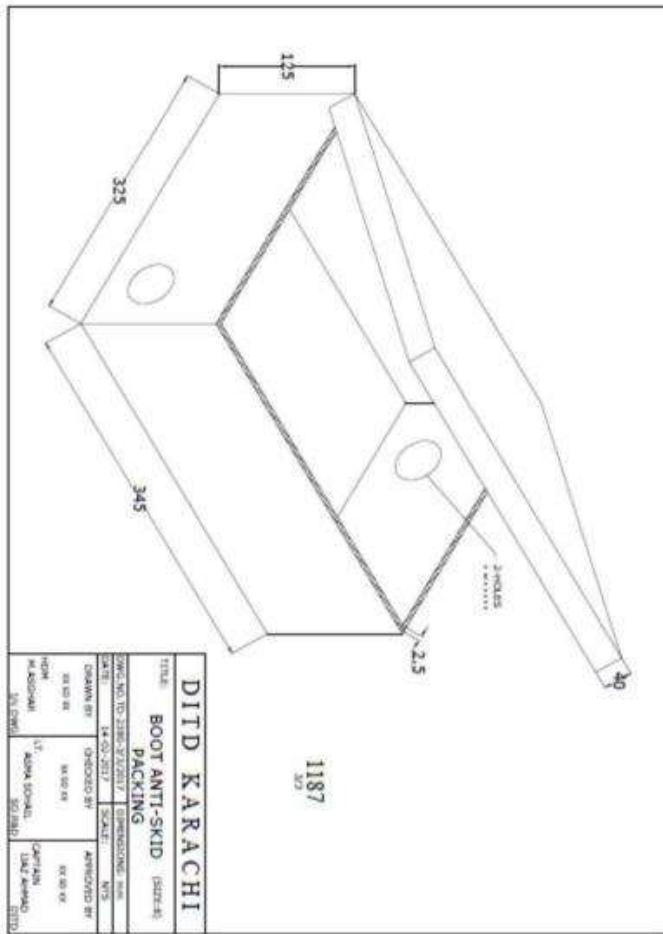

ANNEX D TO
PN SPECIFICATION NO.05/2017
PROMULGATION DATE 04 MAY 2017

TERMS & DEFINITIONS

1. **Inspection Authority**. Chief Inspector of Naval Stores (CINS). His verdict in respect of inspection matters is to be taken as final.
2. **Inspecting Officer**. An officer nominated by the Chief Inspector of Naval Stores (CINS) for carrying out inspection of stores supplied by the supplier, against a specified contract or order, in accordance with the particulars stipulated therein.
3. **Inspector**. The term inspector shall include the "Inspection Authority", inspecting officer and their representatives, duly authorized for the purpose of discharging inspection duties involved.
4. **Sealed Pattern**. It denotes a pattern, sealed and signed by the Inspection Authority & held in his custody, and represents the standard of store in respect of materials, dimensions, design, workmanship and finish, etc. There is only one sealed pattern for each store, which cannot be removed from custody of the inspection authority.
5. **Girth** It is the circumference of the widest part of the toe.

**ANNEX E TO
PN SPECIFICATION NO.05/2017
PROMULGATION DATE 04 MAY 2017**

GUIDELINES FOR INSPECTION – GENERAL DEFECTS			
Defect	Description	Major	Minor
Pairing	Not properly paired i.e. right and left not of the same size and fitting	X	
	Wide variation in appearance of colour	X	
Colour cleanliness and finish	Not specified colour	X	
	Colour not uniform, spots and stains clearly noticeable at a distance of 3 feet (914mm)	X	
	Colour not uniform, spots and stains not plainly visible at a distance of 3 feet (914mm)		X
	Sole and heel edges not properly finished		X
Design, pattern size	Not as specified	X	
	Foreign Object Damage (FOD) free as same can cause catastrophic damage particularly while working in confined areas	X	
	Incorrectly lasted upper	X	
Material	Any components or items not fabricated from the specified materials	X	
Upper leather	Leather not chrome full grain Cow Leather deeply snuffed i.e. fibre structure damaged	X X	
	One or more of the following imperfections: Grub or tick marks opened or badly healed scratches, flay cut, brands, bony, loose, wrinkles or other inferior leather	X	
	Wrinkles not seriously affecting appearance or serviceability		X
	Stretchy vamp	X	
	Stiff tongue	X	
	Flesh side with rough fiber	X	
	Skiving not done or excessively done	X	
	Damage to upper compounds	X	
Construction and workman ship	Any Component or assembly misplaced. Operation committed or not properly performed seriously affecting serviceability or appearance	X	
	Components poorly positioned	X	
	Excessive roughness	X	
Sole	Poor sole adhesion	X	
	Improper trimming of moulded surface	X	
	Damaged outer sole design	X	
	Pits or air bubbles observed on midsole	X	

PN SPECIFICATION NO 05 /2017

	Improper /wrong size marking	X	
Laces & stitching	Any open seam	X	
	Stitching omitted where required	X	
	Loose tension resulting in puckering or damaging the leather	X	
	Stitching incorrectly finished off	X	
Counters	Soft counter (Stiffeners)	X	
Steel Toe cap and its Back seam	Toe soft on top and sides	X	
	Ridges formed on the inside affecting comfort of wearer	X	
	Steel toe cap missing	X	
	Steel toe cap without standard embossing	X	
Inner sole	Insoles not properly feathered, not likely to affect comfort		X
Eyelets	Not the same number of eyelets in each row	X	
	Eyelets not properly Spaced within the row or misalignment between the rows to an extent interfering proper locking	X	
	Number of eyelets less than specified but each row having the same number	X	
	Not specified size	X	
	Poor quality of eyelets	X	
Marking	Missing incomplete, incorrect, and illegible	X	
	Special instructions are missing	X	
Laces	Missing	X	
	Spare pair of laces missing	X	
	Rough and substandard	X	
Identification label	Missing	X	

ANNEX F TO
PN SPECIFICATION NO.05/2017
PROMULGATION DATE 04 MAY 2017

FEED BACK FORM

Item Designation: _____

Pattern #: _____

Parent Equipment: _____

PN SPEC #: _____

Problem Faced: _____

Technical Solution: _____

Financial Effect (if any): _____

Name Stamp

COUNTERSIGNED

Name Stamp

General Requirements/Conditions

ANNEX 'B' TO

Indent No. 125028

Indent Date. 2021-12-02 00:00:

<u>S.No and Description</u>	<u>Firm's Reply (Compiled) Partialy Compiled/Not Compiled</u>	<u>Reference to attached Firm's proposal/Bro chure</u>
<p>1 SCOPE OF SUPPLY/ WORK</p> <p>The Supplier undertakes to deliver equipment/goods/stores including Supplies and Services to the Purchaser on FOR/ FOB Karachi basis as per INCOTERMS 2020 as per details specified in Annex-A (Technical Specifications) and General Terms and Conditions given at Annex-B to this Indent.</p> <p>The Supplier shall, in accordance with the terms and conditions as set forth in the Indent, with due care and diligence, provide the equipment/goods/stores and supply the Services within the date(s) specified in the Project Time Schedule.</p>		
<p>2 PERFORMANCE BANK GUARANTEE (PBG)</p> <p>To ensure timely and correct supply of stores, the Supplier shall furnish an unconditional and irrevocable PBG within 30 days of contract signing from a scheduled Pakistani Bank for an amount equivalent to 10% of the contract value (on a Judicial Stamp Paper of the value of Rs.100.00), in the same currency as that of the Contract and endorsed in the favour of CMA(DP) Rawalpindi. The CMA(DP), Rawalpindi has the like power of seeking encashment of the PBG as if the same has been demanded by the Purchaser himself. This PBG shall remain valid for 60 days beyond the completion of warranty period.</p> <p>If the Supplier fails to issue the Bank Guarantee within the specified period because of circumstances that the Supplier is responsible for, the Purchaser reserves the right of cancelling the Contract.</p> <p>In the event of any material breach of terms of Contract having implication on Time schedule and Scope of Work beyond the acceptable limits defined in this Contract, the Supplier shall be given a written notification to satisfy the breach within 30 days and</p>		

<u>S.No and Description</u>	<u>Firm's Reply (Compiled) Partialy Compiled/Not Compiled</u>	<u>Reference to attached Firm's proposal/Bro chure</u>
<p>if the Supplier fails to take satisfactory remedial actions, Purchaser shall have the right to forfeit the PBG but only to the extent of Purchaser's loss or damage resulting from such material breach. For this purpose, the Supplier undertakes not to hinder/restrain encashment of PBG provided to the Purchaser on account of this contract through any Court, extra judicial or any other process including administrative in nature whatsoever.</p>		
<p>3 PRICES OF THE ITEMS</p> <p>The Supplier should mention the price of all deliverables (i.e. Equipments/ Services, Spares, Documentation, Test Bench/ Tools/ Test Equipment, Trainings, FATs (Factory Acceptance Trials), Installation/ Integration, Acceptance Test/ Trials/ Commissioning etc where applicable) separately in financial quote. The same are to be subsequently incorporated in the contract document.</p>		
<p>4 TRANSFER OF TITLE AND RISK</p> <p>Risk of loss and damage to the Equipment shall be transferred to the PURCHASER according to the 'INCOTERM 2020 used in the Contract and stated in Article 1.</p> <p>Title to the Equipment shall be transferred to the Purchaser when the Supplier has received full payment of the Contract Price.</p>		
<p>5 WARRANTY/ GUARANTEE</p> <p>a. Warranty period of all items except defective/non-operational shall commence from the date of acceptance of Goods/ Equipment, whereas warranty of defective/non-operational equipment (at the time of commissioning/ acceptance) shall commence after defect rectification of equipment.</p> <p>b. The stores and all its associated accessories should be warranted against DPL-15 by the Supplier for a period of 01 year, for all defects in hardware from the date of final acceptance by PN. Software provided with the systems should also have warranty for a minimum period of 05 years for any bugs found in operations. The Supplier shall provide/incorporate all software updates in this period.</p>		

<u>S.No and Description</u>	<u>Firm's Reply (Compiled) Partialy Compiled/Not Compiled</u>	<u>Reference to attached Firm's proposal/Bro chure</u>
<p>c. The Supplier should provide guarantee that the article supplied are of latest version and all modifications/up gradation have been incorporated in the equipment being supplied.</p> <p>d. The Supplier should provide guarantee that the stores produced are of current production and brand new, in accordance with approved drawing, and in all respects. The materials used, whether or not of his manufacture should also be in accordance with the latest appropriate standard specifications.</p> <p>e. The Supplier shall provide guarantee for through life supportability of the equipment and software for at least 05 years after acceptance of the entire system.</p>		
<p>6 NON DISCLOSURE AGREEMENT</p> <p>Any information about the sale/ purchase/ services/ drawings/ infrastructure etc of the project under the contract shall not be communicated to any person, other than the manufacturer/ provider of the stores/ drawings/ machinery/ equipment/ tools etc or to any press or agency not authorized by the Purchaser to receive it. Any breach on this account shall be punished under the Official Secret Act 1923.</p> <p>Promotional rights for publication of the projects are the sole responsibility of the Purchaser, and any use by the consultant shall be subject, in all instances, to the Purchaser's prior written approval.</p>		
<p>7 INSPECTION OF STORES/ ACCEPTANCE TEST PROCEDURE</p> <p>The stores shall be accepted and inspected by following officers/ Reps:</p> <p>(1) Rep of CINS</p> <p>b. Above team shall inspect and test the goods to on Supplier their conformity to the contract specifications.</p> <p>c. The conditions of the contract and technical specifications shall specify inspections/ tests criteria as required by the Purchaser and place of conduct.</p>		

<u>S.No and Description</u>	<u>Firm's Reply (Compiled) Partialy Compiled/Not Compiled</u>	<u>Reference to attached Firm's proposal/Bro chure</u>
<p>d. Purchaser shall notify the Supplier in writing of the identity to any representatives entrusted for this purpose.</p> <p>e. If any inspected or tested goods fail to conform to the specifications, Purchaser may reject them and the Supplier shall either replace the rejected goods or make alterations necessary to meet specification requirements free of cost to Purchaser.</p> <p>f. Purchaser's right to inspect, test and where necessary, reject the goods after arrival in Pakistan shall in no way be limited or waived by reasons of the goods having previously been inspected, tested and passed by Purchaser or its representative prior to the goods shipment from the country of origin.</p>		
<p>8 DISCREPANCY</p> <p>The Supplier shall render a discrepancy report to all concerned within 30 days after receipt of stores for discrepancies found in the consignment. The quantities found short or defective are to be made by the Supplier, without any additional cost on "DDP "consignee's warehouse "within 30 days.</p>		
<p>9 COMPENSATION ON BREACH OF CONTRACT</p> <p>If the Supplier fails to supply of contracted stores or contract is cancelled either on RE or without RE or contract become ineffective due to default of Supplier/ Supplier or stores/ equipment declared defective and caused loss to the Government, Supplier shall be liable to pay to the Government compensation for loss or inconvenience resulting for his default or from the rescission of his contract when such default or rescission take place such compensation shall be in excess to the RE amount, if imposed by the competent authority. Compensation amount in terms of money shall be decided by the purchase officer and shall be deposited by Supplier/ Supplier in Government treasury in the currency of contract.</p>		
<p>10 PENALTY</p> <p>a. The Supplier before making the shipment shall carry out complete test of the equipment at its facilities to ensure that the same has been manufactured as per specifications. In case the</p>		

<u>S.No and Description</u>	<u>Firm's Reply (Compiled) Partialy Compiled/Not Compiled</u>	<u>Reference to attached Firm's proposal/Brochure</u>
<p>equipment does not pass the test/ trials, Purchaser has the right to outright reject the equipment or impose penalty at the rate of 10 - 15% of the value of the relevant equipment/ items.</p> <p>b. The penalty shall not absolve the Supplier to undertake the repairs in Pakistan or abroad at his cost and expense including freight charges. This shall be in addition to the penalties and obligations covered in the contract like warranty/ guarantee obligations on Form DPL-15.</p>		
<p>11 CONTRACT COMPLETION CERTIFICATES</p> <p>Upon completion of all contractual obligations under this Contract, the Supplier shall submit a “No Demand Certificate” to the Purchaser stating that no stores/ goods, Supplies, Services and payments are outstanding. Concurrently, the Purchaser shall certify through a “No Objection Certificate” that the requirement placed by the Purchaser as per terms and conditions set forth in this Contract has been fulfilled. Specimen of Contract Completion Certificate/ No Demand Certificate shall be added in the contract prior contract signing. Upon receipt of both certificates, Bank Guarantee(s) shall be returned by CMA(DP) to the Purchaser for onward return to the Supplier.</p>		
<p>12 COMPLIANCE WITH INTERNATIONAL STANDARDS</p> <p>The Goods/Equipment shall comply with all relevant ISO standards stipulated in the Contract and valid on the date of signature of the Contract. The Parties agree that any variation of any ISO standard after signature of the Contract is deemed explicitly not to be a circumstance within the responsibility of the Supplier. Implementation of any variations to the relevant ISO standards for the purpose of operating the Equipment shall be agreed between the Parties within the contractual change management procedure, prior to realization.</p>		
<p>13 TECHNICAL SCRUTINY</p> <p>Technical scrutiny of quotations forwarded by the bidder shall be carried out by a committee nominated by CO PNCSD as per instructions of NHQs. The TSR committee may ask the Suppliers to demonstrate their equipment or give a presentation for clarification. TSR committee may</p>		

<u>S.No and Description</u>	<u>Firm's Reply (Compiled) Partialy Compiled/Not Compiled</u>	<u>Reference to attached Firm's proposal/Brochure</u>
also visit the OEM premises at the invitation/expense of the Supplier to evaluate the manufacturing/system's capabilities of the OEM.		
<p>14 DELAYS AND LIQUIDATED DAMAGES (LDs)</p> <p>Following Liquidated Damages shall apply for late completion of Consultancy Services as given in the Contract:</p> <p>a. Delay in the completion of all contracted stores/ deliverables up to Twenty One (21) days and for subsequent schedule/orders up to 15 days (from the original Delivery Period only) shall be regarded as "grace period" and no extension/ amendment shall be required. When LD is imposed, grace period shall be inclusive.</p> <p>b. For delays beyond the Grace period of Twenty One (21) days culpably caused by consultant, Purchaser shall have the right to impose LDs.</p> <p>LD, if imposed shall be recovered at the rate of up to 2% but not less than 1% (depending upon the merit of the case as decided by Competent Purchase Officer) of the value of stores supplied late per month or a part of a month for the period exceeding the original delivery period are liable to be imposed on the Supplier by the Purchaser in accordance with DPP&I-35 (Revised 2019), if the stores/ services supplied after the expiry of the delivery date without any valid reasons, subject to provision that the total LD thus imposed shall not exceed 10% of the total value excluding taxes/ duties, freight, KPT, insurance charges of the stores delivered late.</p>		
<p>15 BIDDING PROCEDURE</p> <p>This tender shall be floated on Open Tender using Single Stage Two Envelope Bidding procedure.</p>		
<p>16 LANGUAGE, MEASUREMENTS AND WORKING METHODS</p> <p>All drawings, data-files in soft media, Man-Machinery Interface (MIMI) of software and hardware, all marking and identification systems and</p>		

<u>S.No and Description</u>	<u>Firm's Reply (Compiled) Partialy Compiled/Not Compiled</u>	<u>Reference to attached Firm's proposal/Bro chure</u>
all other documentation required to be produced or delivered to the Purchaser under the Contract shall be written, and meetings conducted, in the English language. Measurements shall be in metric units of measurement unless otherwise specified.		
17 INTEGRITY PACT Integrity Pact duly signed by the Supplier and Purchaser. The principal/Supplier must strictly adhere to the provisions of this pact and any contravention in this regard would be dealt with severely, which may include (but not limited to) Permanent blacklisting of the principal / Supplier and/or initiation of criminal proceedings against the persons / individuals involved in a court of law.		
18 AMENDMENT IN CONTRACT Amendment in the contract if required shall be processed by Purchaser upon mutual agreement of both parties i.e. Purchaser and Supplier and formally issued through amendment in the contract/corrigendum.		
19 FORCE MAJEURE The Supplier shall not be held responsible for any delay occurring in delivery of the Goods, Supplies and Services due to event of Force Majeure, such as acts of God, war, terrorist activities, floods, earthquakes, tsunamis and other such events like, Pandemics, Lock down, acts of Governments or any other authority competent in relation to any action in connection with this Contract (including delay, refusal, denial, revocation or any other decision regarding any Export License/permit), riots, civil commotion, acts of foreign government and its agencies and disturbance directly affecting the deliveries, and events or circumstances, including, but not limited to, any action and/or inaction by or on the part of any other person or entity, on or over which the Supplier has no control. In such an event the Supplier shall inform the Purchaser within 15 (fifteen) days of the happening and within the same timeframe about the discontinuation of such circumstances/ happening in writing. The Party initiating the Force Majeure shall provide the other Party with reasonable proof of the occurrence of any of the aforementioned aspects along with Force Majeure event and of its effects on		

<u>S.No and Description</u>	<u>Firm's Reply (Compiled) Partialy Compiled/Not Compiled</u>	<u>Reference to attached Firm's proposal/Brochure</u>
<p>the delivery of the Supplies or any of its obligations towards this Contract.</p> <p>Once the Party initiating the Force Majeure has provided the reasonable proof of occurrence of Force Majeure event, it shall be verified by the other Party and acknowledged to be realistic. In such case the Force Majeure shall be considered to have occurred.</p> <p>If the delivery of Goods, Supplies and Services to the Purchaser has been delayed by Force Majeure conditions then additional period to the extent of such delay shall be allowed to the Supplier for completion of his obligations so affected without any increase in Contract Price.</p> <p>If Force Majeure is considered present for a continuous period of more than 06 (six) months or exceeding a cumulative period of 12 (twelve) months, then both Parties shall mutually decide future course of action.</p>		
<p>20 TERMINATION OF CONTRACT</p> <p>If at any time during the currency of the contract the Purchaser decides to terminate the contract for any reason whatsoever (other than for reasons of Non-Delivery) he shall have right to do so by giving the Supplier a registered notice to that effect. In that event the Purchaser shall accept delivery at the contract price and terms of such stores/goods/services which are in the actual process of manufacture that is completed and ready for delivery within thirty days after receipt by the Supplier of such notice.</p> <p>In the case of remainder of the undelivered stores/goods/services the Purchaser may elect either:</p> <p>a. To have any part thereof completed and take the delivery thereof at the contract price or.</p> <p>b. To cancel the remaining quantity and pay to the Supplier for the articles or sub-components or raw materials purchased by the Supplier and are in the actual process of manufacture at the price to be determined by the Purchaser. In such a case</p>		

<u>S.No and Description</u>	<u>Firm's Reply (Compiled) Partialy Compiled/Not Compiled</u>	<u>Reference to attached Firm's proposal/Brochure</u>
<p>materials in the process of manufacture shall be delivered by the Supplier to the Purchaser.</p> <p>c. No payment shall however be made for any materials not yet in the actual process of manufacture on the date notice of cancellation is received.</p> <p>d. Should the Supplier fail to deliver goods/services in time as per quality terms of contract or fail to render Bank Guarantee within the stipulated time period or any breach of the contract the Purchaser reserves the right to terminate/cancel the contract fully or any part thereof at the risk and expense (RE) of the Supplier. If due to any reasons Purchaser fails to perform its obligations required and needed for the smooth conduct and management of the Contract, Supplier has a right to initiate legal proceedings.</p>		
<p>21 CONFIDENTIALITY</p> <p>The Supplier and the Purchaser shall keep confidential all information of the other party, whether designated as confidential or not, obtained under or in connection with the Contract and shall not divulge the same to any third party without the written consent of the other party. The provisions of this clause shall not apply to any information in the public domain otherwise than by breach of the Contract; or information obtained from a third party who is free to divulge the same.</p> <p>The Supplier and the Purchaser shall divulge confidential information only to those employees who are directly involved in the Contract or have use of equipment and/or software used in connection with the Contract and shall ensure that such employees are aware of and comply with these obligations as to confidentiality.</p> <p>The Supplier shall undertake that any information about the sale/ purchase of the stores under this contract shall not be communicated to any person, other than the manufacturer/ Supplier/company's lawyer(s), or to any press or agency not authorized by the Purchaser to receive it. Any breach on this account shall be punishable under the Official Secret Act-1923 in addition to termination of the</p>		

<u>S.No and Description</u>	<u>Firm's Reply (Compiled) Partialy Compiled/Not Compiled</u>	<u>Reference to attached Firm's proposal/Brochure</u>
Contract at the risk and expense of the Supplier.		
22 SECURE EXCHANGE OF CORRESPONDENCE All correspondence pertaining to contract between Supplier and PN shall be on secured media.		
23 ASSIGNMENT AND SUBCONTRACTING Neither Party shall assign any of its rights or obligations (in whole or in part) under the Contract without the prior written consent of the other Party, which shall not be unreasonably withheld. The Supplier shall not subcontract any part of the Contract without the written consent of the Purchaser, which shall not be unreasonably withheld.		
24 INTELLECTUAL PROPERTY RIGHTS Unless otherwise agreed in writing, all intellectual property rights arising out of this Contract shall vest in the Supplier. The Purchaser shall have a worldwide, non-exclusive, non-transferable, royalty-free license to use, and have used, that intellectual property for any purpose.		
25 OWNERSHIP OF CONTRACT In the event of a change of ownership of Supplier, the Supplier shall ensure that the legal instrument or mode by which the change of ownership takes place shall have specified provisions to the effect that: a. Such change of ownership shall not in any way change, alter or modify the Terms and Conditions of this Contract, and b. The Supplier under new ownership shall continue to be bound by the Terms and Conditions of this Contract.		

<u>S.No and Description</u>	<u>Firm's Reply (Compiled) Partialy Compiled/Not Compiled</u>	<u>Reference to attached Firm's proposal/Bro chure</u>
<p>26 INDEMNITY</p> <p>In the framework of the implementation of this project, both Parties shall waive off any claim against each other regarding every claim for indemnity for the losses caused to their respective personnel or respective personnel of sub-contractors/agents and their properties. However, if these losses result from deliberate fault or unmistakable error or gross negligence of Supplier or his sub-contractors/agents and/or the Purchaser, the Party involved shall bear alone the burden of the damage repairs.</p>		
<p>27 CERTIFICATION REQUIREMENT</p> <p>Supplier/OEM shall confirm through OEM certificate at the time of supply/delivery of the equipment at consignee that equipment being supplied is proven equipment.</p> <p>Supplier through certificate is to confirm that he shall provide import documents at the time of delivery of stores.</p> <p>Supplier certificate for conformance of 100% indent specifications, any deviation to be clearly indicated in the offer shall be provided at the time of delivery of stores.</p> <p>OEM's "Certificate of Conformity" originating from "Principle" who is neither the OEM nor the OEM's authorized dealer/agent/stockist shall not be acceptable.</p>		
<p>28 RISK PURCHASE</p> <p>In the event of failure on the part of the supplier to comply with the contractual obligations, the contract is liable to be cancelled at the risk and expense of the supplier in accordance with DPP&I-35 (Revised 2019). The Purchaser shall be entitled to receive back all advance payments made by him along with any other compensation as mutually agreed to offset the Purchaser's risk of cost escalation of meeting same requirement from elsewhere.</p>		
<p>29 COURT OF JURISDICTION</p> <p>All disputes arising in connection with this contract shall be sorted out through mutual discussions. Unsettled issues may however be dealt with under</p>		

<u>S.No and Description</u>	<u>Firm's Reply (Compiled) Partialy Compiled/Not Compiled</u>	<u>Reference to attached Firm's proposal/Bro chure</u>
the Laws of Pakistan. The Courts at Rawalpindi shall be the Courts of Jurisdiction for any dispute relating to this contract for adjudication.		
<p>30 TERMS OF PAYMENT</p> <p>a. 100% Contract value of the stores will be paid by the CMA(DP) Rawalpindi to the Suppliers. The amount will be claimed direct from CMA(DP) Rawalpindi on production of the following documents, under a covering letter, a copy of which shall be addressed to DP(NAVY),</p> <p>(1) Bill Form (DP-5 in duplicate) to be completed according to inspection. (2) Received copy of the Inspection Note/Delivery Receipt. (3) Supplier delivery Challan duly received by the Consignee. (4) Copy Registration Certificate of Sales Tax Department.</p> <p>b. Part payment/Part delivery is allowed.</p>		
<p>31 QUALITY STANDARDS</p> <p>The equipment and accessories are manufactured and assembled in accordance with international standards. The quality standards compliance certificate is to be submitted with the offer.</p>		
<p>32 SPECIAL INSTRUCTIONS AS ANNEX C</p> <p>INSPECTION/PACKING/DELIVERY TERMS</p> <p>1. Inspection by CINS.</p> <p>2. a. CO PNCSD may order 15% of contracted quantity against DPL-15 to meet urgent/critical requirement, under intimation to CINS. The firm is required to deliver/supplies within 45 days against receipt of such order. Liquidated Damages (LD) upto 2% per month are liable to be imposed on the Supplier in accordance with DP-35 for late delivery of stores without any valid reason.</p> <p>b. CINS may draw random samples from the stores received by PNCSD against DPL-15 to ascertain quality. After detailed laboratory analysis, suitable price reduction (PR) as authorized may be applied by CINS for minor deviation/non-</p>		

<u>S.No and Description</u>	<u>Firm's Reply (Compiled) Partialy Compiled/Not Compiled</u>	<u>Reference to attached Firm's proposal/Bro chure</u>
<p>conformance from stated PN specification. In case of major deviation/non-conformance, the stores may be rejected.</p> <p>3. INCLUSION OF INSTRUCTIONS REGARDING DISPOSAL OF REJECTED UNIFORMS</p> <p>a. Contracted firm will be responsible for proper disposal of rejected clothing stores. Same are to be amended/destroyed under supervision of PN authorities to prevent their misuse by terrorists/anti social elements.</p> <p>b. In case a supplier intends to sale rejected uniform items in local market, the procurement agency will be approached for approval of sample after suitable alteration of military appearance into civilian fashion. After approval, CINS will inspect the bulk stores once again clear the lot for disposal in local market.</p> <p>c. The contractor/supplier shall submit a certificate/undertaking on firm's letter pad that the firm will be held responsible for any misuse of rejected uniforms.</p> <p>4. In case firm is unable to get approval of advance sample after 6 months from date of contract, then contract cancellation should be recommended by CINS or CSD.</p> <p>5. Marking of stores in accordance with specification NS/MISC/002/80.</p> <p>6. Firm will give two week clear notice for the inspection.</p> <p>7. Free Delivery to Consignee Warehouses.</p> <p>8. As per NHQs instructions promulgated vide NHQ letter ST-P/9314/INS/04 dated 05 April 2006. Rejection of stores supplied by contractors will be dealt as under:</p> <p>a. 1st rejection on govt expense</p> <p>b. 2nd rejection on supplier's expense</p> <p>c. On 3rd rejection, contract cancellation be recommended by CINS or CSD</p> <p>9. Bar Code sticker to be attached on each plastic packet containing Boot Antiskid.</p> <p>10. The purchaser will have the flexibility to extend contract up to 03 Months and also can order 15% excess of the total contracted quantity, from the supplying firm at the contract price.</p> <p>11. Purchaser is not bound to lift the entire quantity of contract.</p> <p>Packing: As per PN Specifications 05/2017.</p>		

<u>S.No and Description</u>	<u>Firm's Reply (Compiled) Partialy Compiled/Not Compiled</u>	<u>Reference to attached Firm's proposal/Bro chure</u>
<p>33 CHECKING OF SUPPLIES AT CONSIGNEE'S END</p> <p>Upon arrival, Supplies shall be checked at consignee's end in the presence of the Purchaser and Supplier's representatives. If for the reasons of economy, or any other reason, the Supplier decides not to nominate his representative for such checking; an advance written notice to this effect shall be given by the Supplier to the consignee prior to or immediately on shipment of stores. In such an event, the Supplier shall clearly undertake that the decision of consignee with regard to quantities and description of the consignment shall be taken, as final and any discrepancy found shall be accordingly made up by the Supplier. In all other cases, the consignee shall inform the Supplier about arrival of consignment immediately on receipt of stores through fax. If no response from the Supplier is received within four (04) working days from initiation of letter through fax, the consignee shall have the right to proceed with the checking without Supplier's representative. Consignee's report on checking of stores shall be binding on the Supplier in such cases.</p>		
<p>34 PROJECT MANAGEMENT REVIEW (PMR) MEETINGS</p> <p>The Supplier's key professionals, covering the various technical disciplines shall attend, actively participate and cooperate with the Purchaser's request for meetings without any additional cost, which shall include but not limited to the following meetings:</p> <p>a. Design Review Meetings. b. Progress timeline/ payment bills meetings. c. Any other meetings held in relation to the project.</p>		
<p>35 CORRUPT GIFTS COMMISSIONS</p> <p>The Supplier shall not:</p> <p>a. Offer or give or agree to give to any person in the service of the Purchaser any gift or consideration of any kind as an inducement or reward for doing or forbearing to do for having done or forborne to do any act in relation to the obtaining or execution of this Contract or for showing or forbearing to show favour or disfavor to any person</p>		

<u>S.No and Description</u>	<u>Firm's Reply (Compiled) Partialy Compiled/Not Compiled</u>	<u>Reference to attached Firm's proposal/Bro chure</u>
<p>in relation to this Contract.</p> <p>b. Enter into this or any other Contract with the Purchaser in connection with which commission has been or agreed to be paid by him or on his behalf, or to his knowledge, unless before the Contract is made, particulars of any such commission and of any agreement for the payment therein have been disclosed in writing to the Purchaser.</p>		
<p>36 MISCELLANEOUS</p> <p>a. The Supplier should provide the copies of standard/ specifications referred to or used for the equipment and its accessories.</p> <p>b. Stores to be accepted on DPL-15 at consignees end.</p> <p>c. Supplier shall provide a conformance certificate that item supplied conforms to relevant international standards.</p> <p>d. The Supplier should mention the price of all deliverables separately in financial quote. The same are to be subsequently incorporated in the contract document.</p>		
<p>37 DESIGN CODES (IF APPLICABLE)</p> <p>a. The Supplier shall provide the Goods, Supplies and Services in accordance with internationally recognized codes, standards and recommended best practices. All specified equipment and material shall comply with recognized international codes and standards.</p> <p>b. The Supplier shall inform the Purchaser in writing all the codes, standards and recommended best practices that he intends adopting throughout the design for the written acceptance and written approval of the Purchaser with 3 x hard copies and 1 x soft copy of all the intended & approved codes, standards and recommended practices.</p>		

<u>S.No and Description</u>	<u>Firm's Reply (Compiled) Partialy Compiled/Not Compiled</u>	<u>Reference to attached Firm's proposal/Bro chure</u>
<p>38 NO LICENSE</p> <p>All Confidential Information shared under this Agreement shall remain the exclusive property of the Purchaser, and the Supplier shall have no rights, by license or otherwise, to use the Confidential Information except as expressly provided herein. No patent, copyright, trademark or other proprietary right is licensed, granted or otherwise conveyed by this Agreement with respect to the Confidential Information to the Supplier.</p>		
<p>39 WORKMANSHIP AND MATERIALS</p> <p>a. All work to be done shall be executed in the manner set out in the Contract. Where the manner of manufacture and execution is not set out in the Contract, the work shall be executed in a proper and workmanlike manner in accordance with recognized good practice. The Supplier shall submit for approval of the purchaser, his detailed method statement(s) for the execution of such items of work as may be desired by the Purchaser. Approval of such method statement(s) shall neither relieve the Supplier of his responsibilities under the Contract nor form any basis for claiming additional costs.</p> <p>b. The Supplier shall give the Purchaser full opportunity to examine, measure and test any work onboard/ Site which is about to be covered up or put out of view. The Supplier shall give due notice to the Purchaser whenever such work is ready for examination, measurement or testing. The Purchaser shall then, unless he notifies the Supplier that he considers it unnecessary, without unreasonable delay carry out the examination, measurement or testing.</p>		
<p>40 CUSTOMS, IMPORT DUTIES, TAXES AND OTHER CHARGES</p> <p>The Purchaser shall pay all applicable customs, import duties taxes and other charges due on the Equipment payable upon its importation into the country of destination.</p> <p>The Supplier shall pay all taxes, assessments, duties, levies or charges levied in the country of the manufacturer of the Equipment in connection with the supply by the Supplier of Equipment and Services.</p>		

<u>S.No and Description</u>	<u>Firm's Reply (Compiled) Partialy Compiled/Not Compiled</u>	<u>Reference to attached Firm's proposal/Bro chure</u>
<p>All amounts stated to be payable by Purchaser pursuant to this Contract exclude any value added tax (VAT), sales tax, service tax, taxes on turnover or similar taxes. If the supply of Equipment or Services hereunder are chargeable to any value added tax, sales tax, service tax,taxes on turnover or similar taxes inside country of destination, and such taxes are not recoverable by the Supplier then such taxes shall be paid and borne by the Purchaser.</p> <p>Purchaser shall pay and bear all other taxes, assessments, duties, levies or charges by whosoever levied in the country of destination of the Equipment.</p> <p>If Purchaser is required by any law to make any deduction or withholding from any amount payable to Supplier under this Contract, then the sum payable in respect of which such deduction or withholding is required to be made shall be increased to the extent necessary to ensure that, after the making of such deduction or withholding, Supplier shall receive (free from any liability in respect of any such deduction or withholding) a net sum equal to the amount which it would have received had no deduction or withholding been required to have been made. Purchaser shall pay any such withholding or deduction to the relevant authority as required by law and shall promptly provide Supplier with an official receipt or certificate in respect of the payment of the withholding or deduction.</p>		
<p>41 LIABILITY</p> <p>The supplier shall not be liable under any circumstances to the buyer, its officers, agent, employees, successors and / or assignees, for any special, consequential and / or incidental damage of whatsoever kind or nature, including, without limitation, any loss, cost, damage loss of revenue or profit or loss of user, incurred or suffered by the buyer or any third party arising out of or in connection with this contract.</p> <p>The foregoing shall not affect buyers right to claim compensation against the supplier for damages suffered by the buyer arising directly from the</p>		

<u>S.No and Description</u>	<u>Firm's Reply (Compiled) Partialy Compiled/Not Compiled</u>	<u>Reference to attached Firm's proposal/Bro chure</u>
<p>performance, bad performance or non-performance of the suppliers duties and / or obligations under the contract provided however that the aggregate liability of the suppliers in connection with this contract for any cause whatsoever including indemnity and risk purchase, shall not exceed hundred percent (100%) of the total price actually paid to the supplier under this contract.</p>		
<p>42 REPEAT ORDER</p> <p>Supplier shall not increase the cost of stores if additional quantity of same item is purchased in next 12 months after commissioning of the equipment. He may however decrease the cost by considering lower market trend.</p>		
<p>43 PROJECT SCHEDULE</p> <p>The Contract shall be executed in accordance with the dates in the Project Schedule. In case of delayed performance of any other dates or periods the Supplier shall strive to compensate such overruns in order to finally meet any subsequent binding dates.</p> <p>If by reason of any change order, or of any act or omission on the part of the Purchaser, or any event of force majeure the Supplier shall be delayed in the completion of the Contract then provided that the Supplier shall as soon as reasonably practicable have given to the Purchaser notice of his claim for an extension of time with supporting details, the Purchaser shall on receipt of such notice grant the Supplier an extension of time as may be reasonable.</p>		

